

Operation Manual

Embroidery and Sewing Machine

Product Code: 888-G26/G30/G32/G34

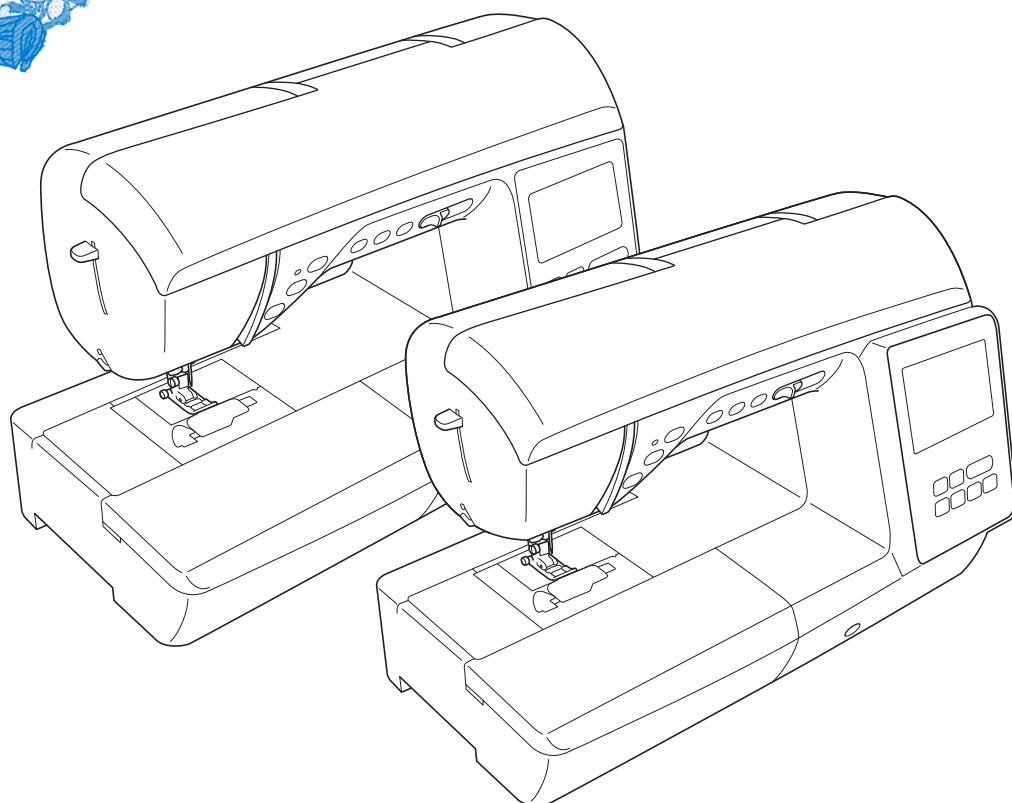

Be sure to read this document before using the machine.
We recommend that you keep this document nearby for future reference.

INTRODUCTION

Thank you for purchasing this machine. Before using this machine, carefully read the "IMPORTANT SAFETY INSTRUCTIONS", and then study this manual for the correct operation of the various functions. In addition, after you have finished reading this manual, store it where it can quickly be accessed for future reference.

IMPORTANT SAFETY INSTRUCTIONS

Please read these safety instructions before attempting to use the machine.

DANGER

- To reduce the risk of electrical shock

1 Always unplug the machine from the electrical outlet immediately after using, when cleaning, making any user servicing adjustments mentioned in this manual, or if you are leaving the machine unattended.

WARNING

- To reduce the risk of burns, fire, electrical shock, or injury to persons.

2 Always unplug the machine from the electrical outlet when making any adjustments mentioned in the instruction manual.

- To unplug the machine, switch the machine to the symbol "O" position to turn it off, then grasp the plug and pull it out of the electrical outlet. Do not pull on the cord.
- Plug the machine directly into the electrical outlet. Do not use an extension cord.
- Always unplug your machine if there is a power failure.

3 Electrical Hazards:

- This machine should be connected to an AC power source within the range indicated on the rating label. Do not connect it to a DC power source or inverter. If you are not sure what kind of power source you have, contact a qualified electrician.
- This machine is approved for use in the country of purchase only.

4 Never operate this machine if it has a damaged cord or plug, if it is not working properly, has been dropped or damaged, or water is spilled on the unit. Return the machine to the nearest authorized Brother dealer for examination, repair, electrical or mechanical adjustment.

- While the machine is stored or in use if you notice anything unusual, such as an odor, heat, discoloration or deformation, stop using the machine immediately and unplug the power cord.
- When transporting the machine, be sure to carry it by its handle. Lifting the machine by any other part may damage the machine or result in the machine falling, which could cause injuries.
- When lifting the machine, be careful not to make any sudden or careless movements, which may cause a personal injury.

5 Always keep your work area clear:

- Never operate the machine with any air openings blocked. Keep ventilation openings of the machine and the foot controller free from the build up of lint, dust, and loose cloth.
- Do not store objects on the foot controller.
- Never drop or insert foreign objects in any opening.
- Do not operate where aerosol (spray) products are being used or where oxygen is being administered.
- Do not use the machine near a heat source, such as a stove or iron; otherwise, the machine, power cord or garment being sewn may ignite, resulting in fire or an electric shock.
- Do not place this machine on an unstable surface, such as an unsteady or slanted table, otherwise the machine may fall, resulting in injuries.

6 Special care is required when sewing:

- Always pay close attention to the needle. Do not use bent or damaged needles.
- Keep fingers away from all moving parts. Special care is required around the machine needle.

- Switch the machine to the symbol “O” position to turn it off when making any adjustments in the needle area.
- Do not use a damaged or incorrect needle plate, as it could cause the needle to break.
- Do not push or pull the fabric when sewing, and follow careful instruction when free motion stitching so that you do not deflect the needle and cause it to break.

7 This machine is not a toy:

- Your close attention is necessary when the machine is used by or near children.
- This product contains small parts. Keep the product out of the reach of children to prevent accidental ingestion of small parts.
- The plastic bag that this machine was supplied in should be kept out of the reach of children or disposed of. Never allow children to play with the bag due to the danger of suffocation.
- Do not use the seam ripper in any other way than how it is intended.
- Do not use outdoors.

8 For a longer service life:

- When using and storing this machine, avoid direct sunlight and high humidity locations. Do not use or store the machine near a space heater, iron, halogen lamp, or other hot objects.
- Do not use cleansers or organic solvents, such as thinner, petroleum ether or alcohol, to clean the machine. Otherwise, the finish may peel off or become scratched.
- Always consult the Operation Manual when replacing or installing any assemblies, the presser feet, needle or other parts to assure correct installation.

9 For repair or adjustment:

- If the light unit is damaged, it must be replaced by an authorized Brother dealer.
- In the event a malfunction occurs or adjustment is required, first follow the troubleshooting table in the back of the Operation Manual to inspect and adjust the machine yourself. If the problem persists, please consult your local authorized Brother dealer.

Use this machine only for its intended use as described in the manual.

Use accessories recommended by the manufacturer as contained in this manual.

The contents of this manual and specifications of this product are subject to change without notice.

For additional product information and updates, visit our website at www.brother.com

SAVE THESE INSTRUCTIONS

This machine is intended for household use.

FOR USERS IN COUNTRIES EXCEPT EUROPEAN COUNTRIES

This appliance is not intended for use by persons (including children) with reduced physical, sensory or mental capabilities, or lack of experience and knowledge, unless they have been given supervision or instruction concerning use of the appliance by a person responsible for their safety. Children should be supervised to ensure that they do not play with the appliance.

FOR USERS IN EUROPEAN COUNTRIES

This appliance can be used by children aged from 8 years and above and persons with reduced physical, sensory or mental capabilities or lack of experience and knowledge if they have been given supervision or instruction concerning use of the appliance in a safe way and understand the hazards involved. Children shall not play with the appliance. Cleaning and user maintenance shall not be made by children without supervision.

FOR USERS IN THE UK, EIRE, MALTA AND CYPRUS ONLY

IMPORTANT

- In the event of replacing the plug fuse, use a fuse approved by ASTA to BS 1362, i.e. carrying the  mark, rating as marked on plug.
- Always replace the fuse cover. Never use plugs with the fuse cover omitted.
- If the available electrical outlet is not suitable for the plug supplied with this equipment, you should contact your authorized Brother dealer to obtain the correct lead.

Federal Communications Commission (FCC) Supplier's Declaration of Conformity (For U.S.A. Only)

Responsible Party: Brother International Corporation
200 Crossing Boulevard
P.O. Box 6911
Bridgewater, NJ 08807-0911
USA
TEL : (908) 704-1700

declares that the product

Product Name: Brother Sewing Machine
Model Number: NQ3700D, NQ3550W

This device complies with Part 15 of the FCC Rules. Operation is subject to the following two conditions: (1) this device may not cause harmful interference, and (2) this device must accept any interference received, including interference that may cause undesired operation.

This equipment has been tested and found to comply with the limits for a Class B digital device, pursuant to Part 15 of the FCC Rules. These limits are designed to provide reasonable protection against harmful interference in a residential installation. This equipment generates, uses, and can radiate radio frequency energy and, if not installed and used in accordance with the instructions, may cause harmful interference to radio communications. However, there is no guarantee that interference will not occur in a particular installation. If this equipment does cause harmful interference to radio

or television reception, which can be determined by turning the equipment off and on, the user is encouraged to try to correct the interference by one or more of the following measures:

- Reorient or relocate the receiving antenna.
- Increase the separation between the equipment and receiver.
- Connect the equipment into an outlet on a circuit different from that to which the receiver is connected.
- Consult the authorized Brother dealer or an experienced radio/TV technician for help.
- This transmitter must not be co-located or operated in conjunction with any other antenna or transmitter.

Important

Changes or modifications not expressly approved by Brother Industries, Ltd. could void the user's authority to operate the equipment.

This equipment complies with FCC/IC radiation exposure limits set forth for an uncontrolled environment and meets the FCC radio frequency (RF) Exposure Guidelines and RSS-102 of the IC radio frequency (RF) Exposure rules. This equipment has very low levels of RF energy that are deemed to comply without testing of specific absorption rate (SAR).

For Users in Canada

This device complies with Industry Canada's licence-exempt RSSs. Operation is subject to the following two conditions:

- (1) This device may not cause interference; and
- (2) This device must accept any interference, including interference that may cause undesired operation of the device.

This equipment complies with FCC/IC radiation exposure limits set forth for an uncontrolled environment and meets the FCC radio frequency (RF) Exposure Guidelines and RSS-102 of the IC radio frequency (RF) Exposure rules. This equipment has very low levels of RF energy that are deemed to comply without testing of specific absorption rate (SAR).

For Users in Mexico

The operation of this equipment is subject to the following two conditions:

- (1) it is possible that this equipment or device may not cause harmful interference, and
- (2) this equipment or device must accept any interference, including interference that may cause undesired operation.

La operación de este equipo está sujeta a las siguientes dos condiciones:

- (1) es posible que este equipo o dispositivo no cause interferencias perjudiciales y
- (2) este equipo o dispositivo debe aceptar cualquier interferencia, incluyendo la que pueda causar su operación no deseada.

Declaration of Conformity (Europe and Turkey only)

We, Brother Industries, Ltd. 15-1 Naeshiro-cho, Mizuho-ku, Nagoya 467-8561 Japan declare that this product is in conformity with the essential requirements of all relevant directives and regulations applied within the European Community.

The Declaration of Conformity (DoC) can be downloaded from Brother support website. Visit support.brother.com

Declaration of Conformity for RE Directive 2014/53/EU (Europe and Turkey only) (Applicable to models with radio interfaces)

We, Brother Industries, Ltd. 15-1 Naeshiro-cho, Mizuho-ku, Nagoya 467-8561 Japan declare that these products are in conformity with the provisions of the RE Directive 2014/53/EU.

The Declaration of Conformity (DoC) can be downloaded from Brother support website. Visit support.brother.com

Wireless LAN (Models with Wireless LAN function only)

This machine supports wireless interface.

Frequency band(s): 2400-2483.5 MHz

Maximum radio-frequency power transmitted in the frequency band(s): Less than 20 dBm(e.i.r.p)

UK Declaration of Conformity (Great Britain only)

We, Brother Industries Ltd. 15-1 Naeshiro-cho, Mizuho-ku, Nagoya 467-8561 Japan declare that these products are in conformity with the relevant UK legislation.

The Declaration of Conformity (DoC) can be downloaded from Brother support website. Visit support.brother.com

UK Declaration of Conformity for Radio Equipment Regulation 2017

(Great Britain only) (Applicable to models with radio interfaces)

We, Brother Industries Ltd. 15-1 Naeshiro-cho, Mizuho-ku, Nagoya 467-8561 Japan declare that these products are in conformity with the provisions of the Radio Equipment Regulation 2017.

The Declaration of Conformity (DoC) can be downloaded from Brother support website. Visit support.brother.com

For Users in Norway

This subsection does not apply for the geographical area within a radius of 20 km from the centre of Ny-Alesund on Svalbard.

Dette underavsnittet gjelder ikke for det geografiske området innenfor en radius av 20 km fra sentrum av Ny-Ålesund på Svalbard.

Terms of Use

IMPORTANT-PLEASE READ CAREFULLY:

This Terms of Use ("Agreement") is a legal agreement between Brother Industries, Ltd. ("Company") and you that governs your use of any Software, installed on or made available by Company for use with sewing or craft products ("Company Product"). The term of "Software" means any and all contents data, design data, data format, firmware of Company Product, and PC application or mobile device application.

By using the Software and Company Product, you shall be deemed to have agreed to be bound by the terms of this Agreement. If you do not agree to the terms of this Agreement, Company is unwilling to license the Software and you are not allowed to use the Software. Amendments and supplements to this Agreement may be attached to the Software.

An individual who accepts this Agreement on behalf of an entity represents to Company that he or she has the legal right to enter into a binding legal agreement for that entity.

Terms and Conditions

1 Grant of License.

- 1.1 Subject to this Agreement, Company hereby grants you a personal, non-exclusive, non-transferable and revocable license to use the Software only within the Company Product.
- 1.2 Your right to use of the Software is licensed and not sold, and solely for your use subject to this Agreement. Company or its suppliers retains all right, title, and interest relating to Software, including without limitation all intellectual property rights relating thereto.

2 Restrictions

- 2.1 Except as expressly set out in this Agreement or as required by any local law, you shall undertake:
 - 2.1.1 not to disassemble, de-compile, reverse engineer, translate or otherwise attempt to learn the source code of the Software (including the data or contents created by using the Company Product or contents editing application software; hereinafter the same shall apply in this Clause 2.);
 - 2.1.2 not to create derivative works based on the whole or any part of the Software;
 - 2.1.3 not to distribute, provide or make available the Software in any form, in whole or in part to any person without prior written consent from Company;
 - 2.1.4 not to copy the Software, except where such copying is incidental to normal use of the Software with Company Product or where it is necessary for the purpose of back-up or operational security;

- 2.1.5 not to transfer, rent, lease, sub-license, loan, translate, merge, adapt, vary, alter or modify, the whole or any part of the Software nor permit the Software or any part of it to be combined with, or become incorporated in, any other programs;
- 2.1.6 to include Company's copyright notice and this Agreement on all entire and partial copies of the Software; and
- 2.1.7 not to use the Software for any purpose (including, but not limited to, use with unauthorized sewing/craft products or software) other than as provided under Clause 1 of this Agreement.

3 No warranty

TO THE EXTENT PERMISSIBLE BY APPLICABLE LAW, THIS SOFTWARE IS PROVIDED TO YOU "AS IS" WITHOUT WARRANTIES OR CONDITIONS OF ANY KIND, WHETHER ORAL OR WRITTEN, EXPRESS OR IMPLIED. COMPANY SPECIFICALLY DISCLAIMS ANY IMPLIED WARRANTIES OR CONDITIONS OF MERCHANTABILITY, SATISFACTORY QUALITY, NON-INFRINGEMENT AND/OR FITNESS FOR A PARTICULAR PURPOSE.

4 Limitation of liability

- 4.1 COMPANY SHALL NOT BE LIABLE TO YOU, ITS END-USERS OR ANY OTHER ENTITY FOR ANY LOSS OF PROFITS OR INCOME OR SAVINGS, LOSS OF DATA, INTERRUPTION OF USE, OR CONSEQUENTIAL, INCIDENTAL, SPECIAL, PUNITIVE OR INDIRECT DAMAGES INCURRED BY SUCH PARTY (WHETHER IN AN ACTION IN CONTRACT OR TORT), EVEN IF COMPANY HAS BEEN ADVISED OF THE POSSIBILITY OF SUCH DAMAGES, ARISING OUT OF OR RELATING TO THE SOFTWARE, SUPPORT SERVICE OR THIS AGREEMENT. THESE LIMITATIONS SHALL APPLY TO THE MAXIMUM EXTENT ALLOWED BY APPLICABLE LAW NOTWITHSTANDING ANY FAILURE OF ESSENTIAL PURPOSE OF ANY LIMITED REMEDY.
- 4.2 NOTWITHSTANDING THE CLAUSE 3 OR 4.1 HEREOF, THIS AGREEMENT DOES NOT PURPORT TO EXCLUDE OR RESTRICT COMPANY'S LIABILITY FOR DEATH OR PERSONAL INJURY RESULTING FROM NEGLIGENCE OR LIMIT THE STATUTORY RIGHTS OF A CONSUMER.

5 Termination

- 5.1 Company shall have the right to terminate this Agreement at any time by providing a written notice to you if you commit a material breach of any terms of this Agreement and fail to immediately rectify such breach upon Company's request.
- 5.2 Upon termination for any reason all rights granted to you under this Agreement shall cease, you shall cease all activities authorized by this Agreement and you shall immediately delete or remove the Software from all computer equipment in your possession and delete or destroy all copies of the Software or its derivative works in your possession. In addition to the above, you shall delete contents or design data created by you from the Company Product in your possession.

6 Miscellaneous terms

- 6.1 You shall not export or re-export the Software or any copy or adaptation thereof in violation of any applicable laws or regulations.
- 6.2 You shall not assign all or any part of this Agreement to any third party or any interest therein, without prior written consent of Company. A change of control or reorganization of you pursuant to a merger, sale of assets or stock shall be deemed to be an assignment under this Agreement.
- 6.3 You agree that a breach of this Agreement will cause irreparable injury to Company for which monetary damages would not be an adequate remedy and Company shall be entitled to seek equitable relief in addition to any remedies it may have hereunder or at law without a bond, other security, or proof of damages.
- 6.4 If any provisions of this Agreement shall be declared or determined as void or unenforceable by a court of competent jurisdiction, such provisions shall be severable and independent from the other provisions of this Agreement and the validity of the other provisions and of the entire Agreement shall not be affected thereby.
- 6.5 This Agreement, together with all exhibits or other attachments referenced herein, constitutes the entire agreement between the parties on the subject matter hereof, and supersedes all proposals, oral and written, between the parties on this subject.
- 6.6 If Company fails to insist that you perform any of your obligations under this Agreement, or if Company does not enforce any rights against you, or if Company delay in doing so, that will not mean that Company have waived any rights against you and will not mean that you do not have to comply with those obligations. If Company does waive a default by you, Company will only do so in writing, and that will not mean that Company will automatically waive any later default by you.

- 6.7 This Agreement is governed by the laws of Japan and Japanese Courts shall have exclusive jurisdiction with respect to this Agreement except with regard to enforcement in which case the jurisdiction of the Japanese Courts shall be non-exclusive.
- 6.8 The Company may update this Agreement in the below cases: A) When the changes are made for the users' benefit, or B) When the updates to the Agreement are adequate, reasonable, and not contrary to the purposes of the Agreement.
The Company will notify you and give you the opportunity to review any material changes or updates to the Agreement, by posting a notice on the Company's website or a website specified by the Company at least 30 days before the Agreement enters into effect. Once the updated Agreement is in effect, you will be bound by it if you continue to use the Software.

WARNING SIGN

■ Side cutter (sold separately with some models)

The following warning label pertains to the side cutter. Do not touch the knives or connecting fork of the side cutter while sewing to avoid equipment damage or injury. For details, refer to "Sewing overcasting stitches using the side cutter (sold separately with some models)" on page 53.

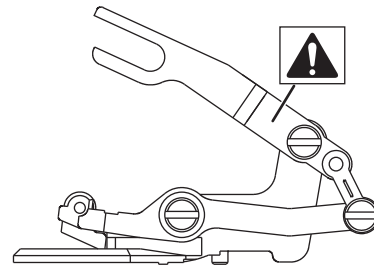

OPEN SOURCE LICENSING REMARKS

This product includes open-source software. To see the open source licensing remarks, please go to the manual download section on your model's home page of Brother support website at "<http://s.brother/cpham/>".

TRADEMARKS

WPA™ and WPA2™ are trademarks of Wi-Fi Alliance®.

Any trade names and product names of companies appearing on Brother products, related documents and any other materials are all trademarks or registered trademarks of those respective companies.

COPYRIGHT AND LICENSE

This product includes software developed by the following vendor:
©2008 Devicescape Software, Inc.

PRECAUTION FOR WIRELESS CONNECTION

Make sure you use a router or firewall when connecting your machine to the Internet to protect it against unauthorized access from the Internet.

CONTENTS

Chapter 1 GETTING READY	9	Chapter 4 EMBROIDERY	79
Names of Machine Parts	9	Embroidering Preparation	79
Included accessories	11	Attaching the embroidery foot.....	79
Turning the Machine On/Off	12	Attaching the embroidery unit	80
LCD Operation	13	Embroidering attractive finishes	81
Viewing the LCD.....	13	Hooping the fabric in the embroidery frame	82
Settings screen.....	15	Attaching the embroidery frame.....	84
Adjusting input sensitivity for operation keys.....	17	Embroidering	85
Wireless Network Connection Functions	17	Selecting an embroidery pattern	85
Operations available with a wireless network connection	17	Embroidering a pattern	89
Enabling a wireless network connection.....	18	Embroidery foot auto down	91
Using the wizard to set up the wireless network connection	18	Adjusting thread tension	91
Winding/Installing the Bobbin	20	Adjusting the bobbin case (with no color on the screw)	92
Winding the bobbin	20	Using the automatic thread cutting function (End Color Trim)	93
Installing the bobbin.....	22	Using the thread trimming function (Jump Stitch Trim).....	93
Upper Threading	24	Embroidering the appliqué patterns	94
Threading the upper thread	24	Using a frame pattern to make an appliqué.....	95
Pulling up the bobbin thread.....	26	Split embroidery patterns	96
Fabric/Thread/Needle Combinations	27	Editing Patterns (Pattern Editing Screen)	96
Replacing the Needle	28	Editing Patterns (Embroidery Settings Screen)	98
Checking the needle.....	28	Aligning the pattern and the needle position.....	99
Replacing the needle.....	28	Embroidering linked characters.....	99
Replacing the Presser Foot	29	Thread color sorting.....	100
Replacing the presser foot	29	Using the Memory Function	101
Removing and attaching the presser foot holder	30	Saving embroidery patterns.....	101
		Retrieving embroidery patterns	102
Chapter 2 SEWING BASICS	31	Chapter 5 APPENDIX	103
Sewing	31	Care and Maintenance	103
Stitch types	31	Cleaning the LCD	103
Basic sewing	31	Cleaning the machine surface.....	103
Combining stitch patterns.....	33	Restrictions on oiling	103
Sewing reverse/reinforcement stitches	34	Precautions on storing the machine	103
Automatic reverse/reinforcement stitching.....	34	Cleaning the race.....	103
Automatic thread cutting	35	Touch panel is malfunctioning.....	104
Automatic presser foot lowering function	36	Troubleshooting	105
Automatic fabric sensor system (Automatic presser foot pressure).....	36	Upper thread tightened up.....	105
Pivoting.....	37	Tangled thread on wrong side of fabric.....	105
Setting the stitch width/stitch length/"L/R Shift"	38	Incorrect thread tension	106
Adjusting the Thread Tension	38	Fabric is caught in the machine and cannot be removed ...	106
Useful Sewing Tips	39	If the thread becomes tangled under the bobbin winder seat	108
Sewing tips	39	List of symptoms	109
Sewing an even seam allowance	40	Error messages	112
Sewing various fabric	41	How can I find the wireless security information (SSID and network key).....	115
Hands-free raising and lifting of the presser foot.....	43	Operation beeps	115
Chapter 3 VARIOUS STITCHES	45	Specifications	116
Stitch Chart	45	Updating Your Machine's Software	116
Utility Stitches	52	Index	117
Overcasting stitches	52		
Blind hem stitching	54		
Buttonhole sewing.....	56		
Button sewing	58		
Zipper insertion.....	59		
Zipper/piping insertion	61		
Appliqué, patchwork and quilt stitching.....	62		
Other stitching applications.....	66		
Making step stitch patterns	72		
Making Adjustments	73		
Using the Memory Function	74		
Saving stitch patterns.....	75		
Retrieving stitch patterns	75		
MY CUSTOM STITCH	76		

Chapter 1 GETTING READY

Note

- Be sure to install the latest software. Refer to “Updating Your Machine’s Software” on page 116.

Names of Machine Parts

The appearance may differ depending on the machine model you purchased.

Main parts

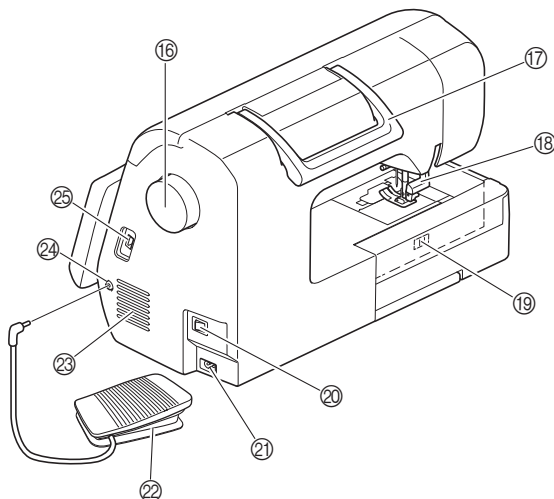
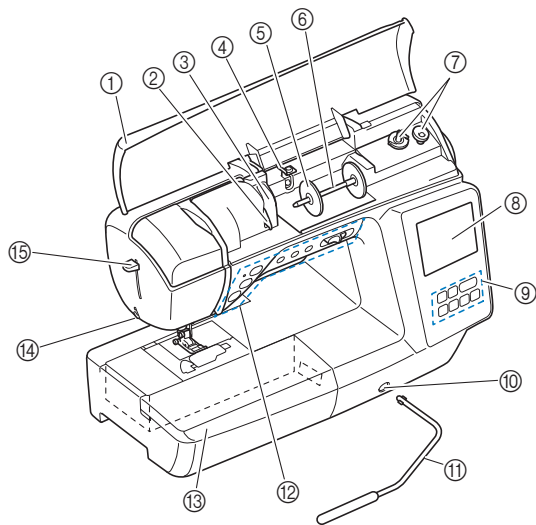

- ① Top cover (page 20)
- ② Thread guide plate (page 21)
- ③ Thread guide cover
- ④ Bobbin winding thread guide and pretension disk (page 21)
- ⑤ Spool cap (page 20)
- ⑥ Spool pin (page 20)
- ⑦ Bobbin winder (page 20)
- ⑧ LCD (liquid crystal display) (page 13)

- ⑨ Operation panel (page 11)
- ⑩ Knee lifter mounting slot (page 43)
- ⑪ Knee lifter (page 43)
- ⑫ Operation buttons and sewing speed controller (page 10)
- ⑬ Flat bed attachment (page 11, 40)
- ⑭ Thread cutter (page 25)
- ⑮ Needle threader lever (page 26)
- ⑯ Handwheel
Turn the handwheel toward you (counterclockwise) to raise and lower the needle to sew one stitch.
- ⑰ Handle
Carry the machine by its handle when transporting.
- ⑱ Presser foot lever
Raise and lower the presser foot lever to raise and lower the presser foot.
- ⑲ Feed dog position switch (page 65)
Use the feed dog position switch to raise and lower the feed dogs.
- ⑳ Main power switch (page 12)
- ㉑ Power supply jack (page 12)
- ㉒ Foot controller (page 32)
- ㉓ Air vent
The air vent allows the air surrounding the motor to circulate. Do not cover the air vent while the machine is being used.
- ㉔ Foot controller jack (page 32)
- ㉕ USB port (for a USB flash drive) (page 75, 101)

Needle and presser foot section

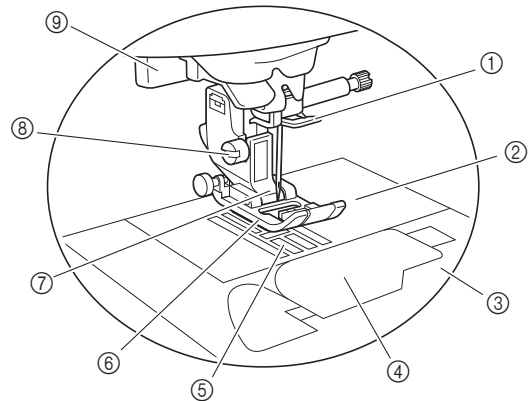

- ① Needle bar thread guide (page 25)
- ② Needle plate (page 41)
- ③ Needle plate cover (page 23)
- ④ Bobbin cover/bobbin case (page 23, 104)
- ⑤ Feed dogs
The feed dogs feed the fabric in the sewing direction.
- ⑥ Presser foot
The presser foot applies pressure consistently on the fabric as the sewing takes place. Attach the appropriate presser foot for the selected stitch.
- ⑦ Presser foot holder (page 30)
- ⑧ Presser foot holder screw (page 30)
- ⑨ Buttonhole lever (page 57)

■ Embroidery unit

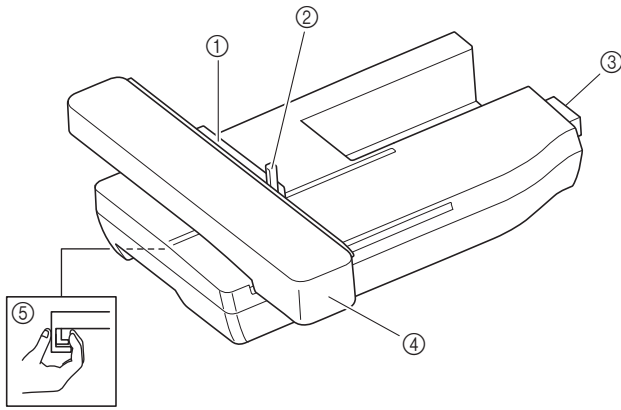

- ① Embroidery frame holder (page 84)
- ② Frame-securing lever (page 84)
- ③ Embroidery unit connection (page 80)
- ④ Carriage (page 80)
- ⑤ Release button (page 81)

■ Operation buttons

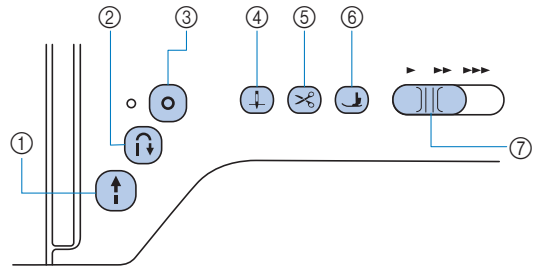



- ① **“Start/Stop” button** 

Press the “Start/Stop” button to start or stop sewing. The button changes color according to the machine’s operation mode.

 - Green: The machine is ready to sew or is sewing.
 - Red: The machine cannot sew.
 - Orange: The machine is winding the bobbin thread, or the bobbin winder shaft is moved to the right side.
- ② **Reverse stitch button** 

Press the reverse button to sew reverse or reinforcement stitches depending on the selected stitch pattern. (page 34)
- ③ **Reinforcement stitch button** 

Press the reinforcement button to sew a single stitch repeatedly and tie-off. (page 34)
For character/decorative stitches, press this button to end with a full stitch instead of at a mid-point.
The LED beside the button automatically lights up while the stitch is being sewn and goes off when sewing is finished.
- ④ **Needle position button** 

Press the needle position button to raise or lower the needle. Pressing the button twice sews one stitch.
- ⑤ **Thread cutter button** 

Press the thread cutter button after sewing is stopped to cut both the upper and the bobbin threads.
- ⑥ **Presser foot lifter button** 

Press this button to lower the presser foot and apply pressure to the fabric. Press this button again to raise the presser foot.
- ⑦ **Sewing speed controller**

Slide the sewing speed controller to adjust the sewing speed.

■ Operation panel and operation keys

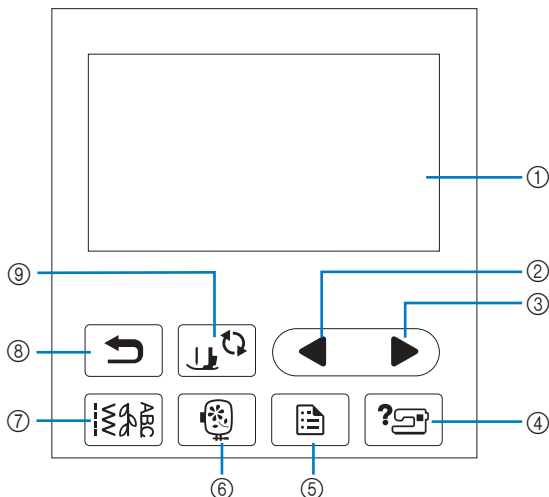

- ① **LCD (liquid crystal display) (touch panel)**
Selected pattern settings and messages are displayed. Touch the keys displayed on the LCD to perform operations. For details, refer to “LCD Operation” on page 13.
- ② **Previous page key** ◀
Displays the previous screen when there are items that are not displayed on the LCD.
- ③ **Next page key** ▶
Displays the next screen when there are items that are not displayed on the LCD.
- ④ **Help key** ?
Press to get help on using the machine.
- ⑤ **Settings key** [Settings icon]
Press to set the needle stop position, the buzzer sound, and more.
- ⑥ **Embroidery key** [Embroidery icon]
Press to display the pattern type selection screen.
- ⑦ **Utility stitch key** [Utility stitch icon]
Press to sew a utility stitch or decorative stitch.
- ⑧ **Back key** [Back icon]
Press to return to the previous screen.
- ⑨ **Presser foot/Needle exchange key** [Presser foot/Needle exchange icon]
Press this key before changing the needle, the presser foot, etc. This key locks all key and button functions to prevent operation of the machine.

Note

- The operation keys of this machine are capacitive touch sensors. Operate the keys by directly touching them with your finger. The response of the keys varies according to the user. The pressure exerted on the keys does not affect the response of the keys.
- Since the operation keys react differently depending on the user, adjust the setting for “Adjusting input sensitivity for operation keys” on page 17.
- When using an electrostatic touch pen, make sure that its point is 8 mm or more. Do not use a touch pen with a thin point or a unique shape.

Included accessories

For included accessories of your machine, refer to the additional sheet “Included Accessories”.

Pull the top of the flat bed attachment to open the accessory compartments.

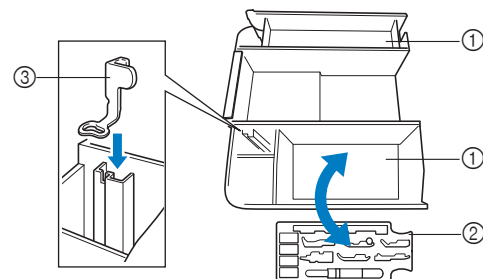
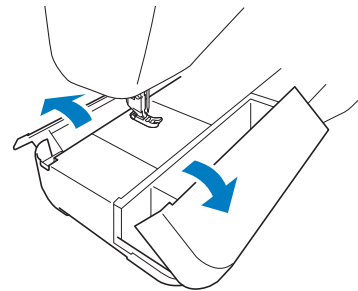

- ① Storage space of the flat bed attachment
- ② Presser foot accessory tray
- ③ Embroidery foot “U”

Turning the Machine On/Off

⚠ WARNING

- Use only regular household electricity for the power source. Using other power sources may result in fire, electric shock, or damage to the machine.
- Make sure that the plugs on the power cord are firmly inserted into the electrical outlet and the power cord receptacle on the machine. Otherwise, a fire or electric shock may result.
- Do not insert the plug on the power cord into an electrical outlet that is in poor condition.
- Turn the main power to OFF and remove the plug in the following circumstances:
 - When you are away from the machine
 - After using the machine
 - When the power fails during use
 - When the machine does not operate correctly due to a bad connection or a disconnection
 - During electrical storms

⚠ CAUTION

- Use only the power cord included with this machine.
- Do not use extension cords or multi-plug adapters with any other appliances plugged into them. Fire or electric shock may result.
- Do not touch the plug with wet hands. Electric shock may result.
- When unplugging the machine, always turn the main power to OFF first. Always grasp the plug to remove it from the electrical outlet. Pulling on the cord may damage the cord, or lead to fire or electric shock.
- Do not allow the power cord to be cut, damaged, modified, forcefully bent, pulled, twisted, or bundled. Do not place heavy objects on the cord. Do not subject the cord to heat. These things may damage the cord, or cause fire or electric shock. If the cord or plug is damaged, take the machine to your authorized Brother dealer for repairs before continuing use.
- Unplug the power cord if the machine is not to be used for a long period of time. Otherwise, a fire may result.

- (For U.S.A. only)
This appliance has a polarized plug (one blade wider than the other). To reduce the risk of electrical shock, this plug is intended to fit in a polarized electrical outlet only one way. If the plug does not fit fully in the electrical outlet, reverse the plug. If it still does not fit, contact a qualified electrician to install the proper electrical outlet. Do not modify the plug in any way.

- 1 Make sure that the machine is turned off (the main power switch is set to “O”), and then plug the power cord into the power supply jack on the right side of the machine.
- 2 Insert the plug of the power cord into a household electrical outlet.

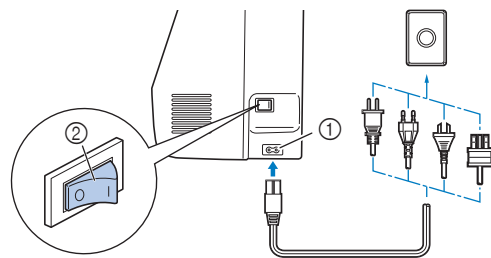

- ① Power supply jack
- ② Main power switch

- 3 Press the right side of the main power switch on the right side of the machine to turn the machine on (set it to “I”).

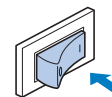

→ The light, LCD and the “Start/Stop” button light up when the machine is turned on. The needle and the feed dogs will make a sound when they move; this is not a malfunction.

- 4 When the machine is turned on, the opening movie is played. Press anywhere on the screen.

💡 Note

- When you first turn on the machine, select the language of your choice.

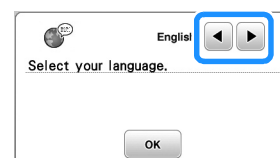

- 5 To turn off the machine, press the left side of the main power switch (set it to “O”).

LCD Operation

Viewing the LCD

Press a key with your finger to select the stitch pattern, to select a machine function, or to select an operation indicated on the key. The screen below appears when you press  on the operation panel.

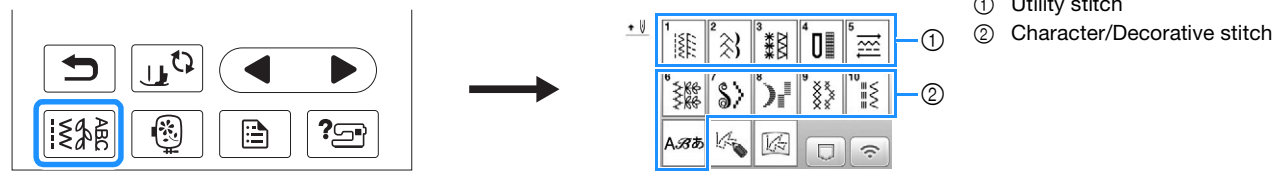

Utility stitch screen

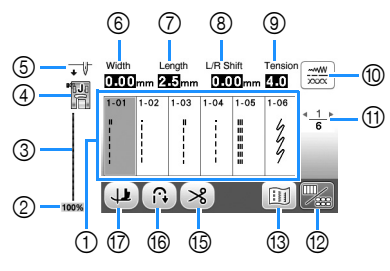

Utility stitch editing screen

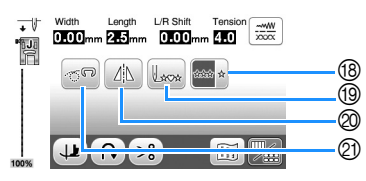

Character/Decorative stitch screen

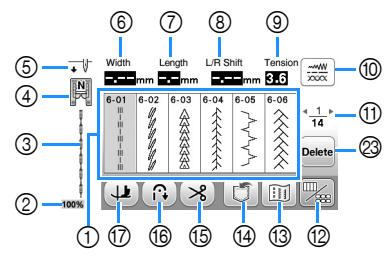



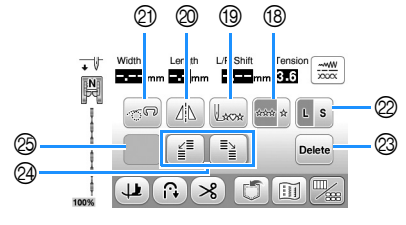





Character/Decorative stitch editing screen



Memo

- Some editing functions cannot be used with certain stitch patterns. Only the functions for the displayed keys are available when a stitch pattern is selected.

No.	Display	Key Name	Explanation	Page
①	-	Stitches	Press the key for the stitch you want to sew.	31
②		Stitch pattern display size	Shows the approximate size of the stitch pattern selected. 100%: Nearly the same size as the sewn stitch pattern 50%: 1/2 the size of the sewn stitch pattern 25%: 1/4 the size of the sewn stitch pattern	-
③	-	Stitch preview	Shows a preview of the selected stitch.	-
④		Presser foot	Shows presser foot to be used. Before sewing, install the presser foot indicated here. <div style="display: flex; justify-content: space-around;"> <div style="text-align: center;">  Zigzag foot "J"  Monogramming foot "N"  Overcasting foot "G"  Buttonhole foot "A" </div> <div style="text-align: center;">  Blind stitch foot "R"  Button fitting foot "M"  Side cutter "S" </div> </div> <p>* The symbols for certain presser feet, such as zipper foot "I" and the quilting foot, may not appear in the screen.</p>	29

No.	Display	Key Name	Explanation	Page
⑤		Needle position setting	Shows single or twin needle mode setting, and the needle stop position. : Single needle/down position : Twin needle/down position : Single needle/up position : Twin needle/up position	15
⑥	Width 0.00mm	Stitch width	Shows the stitch width of the currently selected stitch pattern.	38
⑦	Length 2.5mm	Stitch length	Shows the stitch length of the currently selected stitch pattern.	38
⑧	L/R Shift 0.00mm	L/R Shift	Shows the distance of left/right shift from the original position.	38
⑨	Tension 4.0	Thread tension	Shows the automatic thread tension setting for the currently selected stitch pattern.	38
⑩		Manual adjustment key	Press this key to display the adjustment screen of the stitch width, stitch length, “L/R Shift” and thread tension.	38
⑪		Page display	Shows additional pages that can be displayed.	-
⑫		Edit/stitch switching key	Press this key to toggle between the stitch editing screen and the stitch screen.	13
⑬		Image key	Shows a preview of the sewn image. Press to change the thread color in the image to red, blue, or black.	-
⑭		Memory key	Press this key to save combined stitch patterns.	75
⑮		Automatic thread cutting key	Press this key to set the automatic thread cutting function.	35
⑯		Automatic reverse/reinforcement key	Press this key to use the automatic reverse/reinforcement stitch function.	34
⑰		Pivot key	Press this key to select the pivot function.	37
⑱		Single/repeat sewing key	Press this key to choose single stitch pattern or continuous stitch patterns. Depending on the selected stitch, this key may be disabled. To finish a complete motif while sewing the stitch pattern continuously, you can press while sewing. The machine will automatically stop when the motif is finished.	-
⑲		Back to beginning key	When sewing is stopped, press this key to return to the beginning of the stitch pattern.	-
⑳		Mirror image key	After selecting the stitch pattern, use this key to create a horizontal mirror image of the stitch pattern.	-
㉑		Free motion mode key	Press this key to enter free motion sewing mode.	64
㉒		Size selection key	Use this key to select the size of the decorative stitch pattern or character stitch pattern (large, small).	-
㉓		Delete key	Press this key to delete the selected stitch pattern. When you make a mistake in combining stitch patterns, use this key to delete stitch patterns.	-
㉔		Step stitch keys	Use these keys to make step stitch patterns.	72
㉕	Some of the following keys will appear, depending on the selected stitch pattern.			
		Elongation key	When 7 mm satin stitch patterns are selected, press this key to choose from 5 automatic length settings, without changing the stitch zigzag width or stitch length settings. 	-
		Thread density key	After selecting the satin stitch pattern , use this key to change the thread density of the stitch pattern. : Low density : High density If the stitches bunch when thread density is changed to , return the thread density to . If you continue sewing when the stitches are bunched, the needle may bend or break.	-
		Character spacing key	Press this key to change the spacing of character stitch patterns. Spacing changes are valid not only while entering characters but also before and after the entering of characters.	-

Settings screen

Press to change the default machine settings. Press or , after you changed necessary settings.

Memo

- The latest version of software is installed in your machine. Check with your local authorized Brother dealer or at “ <http://s.brother/cpham/> ” for available updates.
- You can save the current settings screen image in a USB flash drive by pressing when the USB flash drive is inserted into the USB port. The files are saved in a folder labeled “bPocket”.

■ Sewing settings

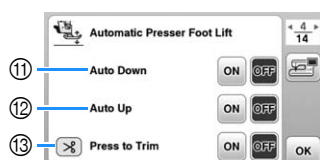
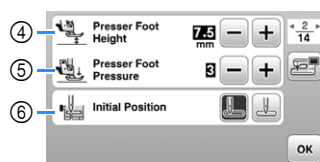

- 1 Select whether to use the sewing speed controller to determine the zigzag width. (page 66)
- 2 Make adjustments to character or decorative stitch patterns. (page 73)
- 3 Set to [ON] when using twin needle. (page 71)
- 4 Adjust the height of the presser foot when the presser foot is raised.
- 5 Adjust the presser foot pressure. The higher the number, the greater the pressure will be. Set the pressure at [3] for normal sewing.
- 6 Select either “1-01 Straight stitch (Left)” or “1-03 Straight stitch (Middle)” as the utility stitch that is automatically selected when the machine is turned on.
- 7 Adjust the height of the presser foot when sewing is stopped when the pivot key is selected. (page 37)
- 8 Adjust the height of the presser foot when the machine is set to free motion sewing mode. (page 64)
- 9 When set to [ON], the thickness of the fabric is automatically detected by an internal sensor while sewing. This enables the fabric to be fed smoothly. (page 36)

- 10 When set to [ON], reinforcement stitches are sewn at the beginning and/or end of sewing for a reinforcement stitch pattern, even when the (Reverse stitch button) is pressed.
- 11 When set to [ON], pressing the “Start/Stop” button (or depressing the foot controller) automatically lowers the presser foot when it is raised, allowing sewing to begin.
- 12 When set to [ON], pressing the “Start/Stop” button (or releasing the pedal of the foot controller) to stop sewing, it will then automatically raise the presser foot. The presser foot is raised to the height specified for [Presser Foot Height] on page 2 of the settings screen. When the pivot setting is selected, the presser foot is raised to the height specified for [Pivoting Height] on page 3 of the settings screen.
- 13 When set to [ON], pressing (Thread cutter button) automatically lowers the presser foot when it is raised, allowing the thread to be cut. After the thread is cut, the presser foot is raised again.

■ Embroidery settings

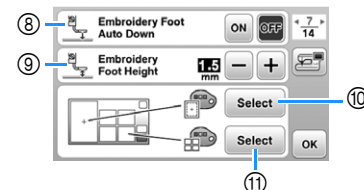
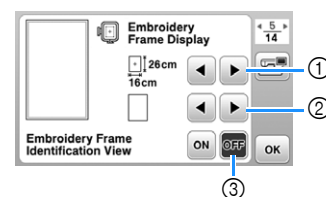

- 1 Select the embroidery frame to be used.
- 2 Select the center mark and grid lines that are displayed.
- 3 When set to [ON], you can only select the embroidery pattern corresponding to the embroidery frame size that you selected in ①. (page 86)
- 4 Change the thread color display on the embroidery screen; thread number, color name. (page 89)
- 5 When the thread number [#123] is selected, select from thread brands. (page 89)
- 6 Select the maximum embroidery speed setting.
- 7 Adjust the upper thread tension for embroidering. (page 91)
- 8 When set to [ON], pressing the "Start/Stop" button when the presser foot is raised automatically lowers the presser foot before starting embroidering. (page 91)
- 9 Select the height of the embroidery foot during embroidering. (page 82)
- 10 Select the color of the background for the embroidery display area.
- 11 Select the color of the background for the thumbnail area.
- 12 Select the size of pattern thumbnails.
- 13 Select the display units (mm/inch).

■ General settings

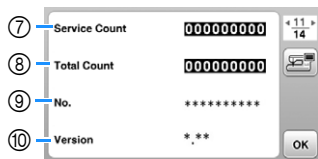
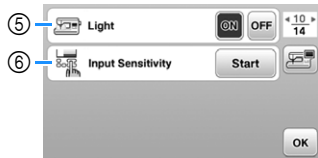

- ① Select the needle stop position (the needle position for when the machine is not being operated) to be up or down.
- ② Select whether to hear the beep operation sound.
- ③ Select whether to display the opening screen when the machine is turned on.
- ④ Select the display language.
- ⑤ Select whether to turn work area light on or off.
- ⑥ Select the level of the input sensitivity for operation keys. (page 17)
- ⑦ Display the service count which is a reminder to take your machine in for regular servicing. (Contact your authorized Brother dealer for details.)
- ⑧ Display the total number of stitches sewn on this machine.
- ⑨ The [No.] is the internal machine number for your machine.
- ⑩ Display the program version installed on your machine.

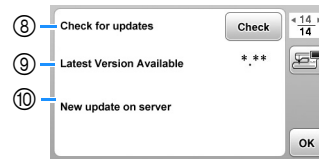
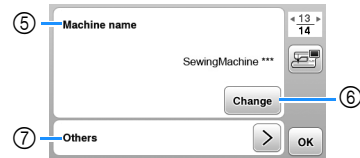
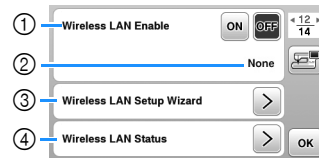

■ Wireless LAN settings





- ① Enable/disable the wireless LAN function. (page 18).
- ② Display the connected SSID. (page 18)
- ③ Set the machine to connect wireless LAN function. (page 18)
- ④ Check the wireless LAN status.
- ⑤ Display the machine name of wireless LAN function.
- ⑥ Change [Machine name].
- ⑦ Display a menu to perform other settings or reset the connection settings of the wireless LAN settings. (page 19)
- ⑧ Check the latest version of the software. The version will display in [Latest Version Available].
- ⑨ Display the latest version of the software.
- ⑩ Displays a message if [New update on server] is available for this machine. If [New update on server] appears, update the machine. (page 116)

Adjusting input sensitivity for operation keys

You can adjust the sensitivity of the operation keys to 5 levels. Display the settings screen to set desired level.

- 1 Press  to display the settings screen.
- 2 Display page 10 by pressing  .
- 3 Press [Start].



- 4 Adjust the [Input Sensitivity] by pressing  .
 - The higher the setting, the more sensitive the keys will be. The default setting is [3].
 - We recommend selecting the highest setting if an electrostatic touch pen is being used.
 - While adjusting the input sensitivity, press  to check whether the key responds. When the key responds, the setting value indicating the sensitivity blinks.

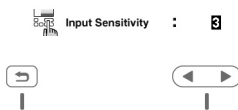

- 5 Press  to return to previous screen.

■ If the machine does not respond when an operation key is pressed

Turn machine off, then hold down  (Thread cutter button) and turn on the machine to reset [Input Sensitivity]. Display the settings screen, and then adjust the [Input Sensitivity] again.

Wireless Network Connection Functions

Operations available with a wireless network connection

This machine supports a wireless network connection. The following useful operations will be available if the machine is connected to a wireless network.

Note

- Connect the machine and your computer to the same network.
- Wirelessly transfer an embroidery pattern from your computer to the machine by using the dedicated Windows application (Design Database Transfer). The application can be downloaded from the following URL.
<http://s.brother/cahka/>
- * Settings must be specified in Design Database Transfer. For more information, refer to the manual for Design Database Transfer.

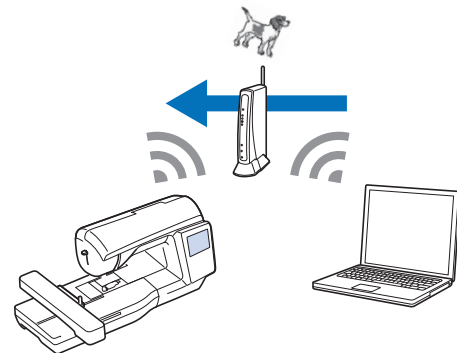

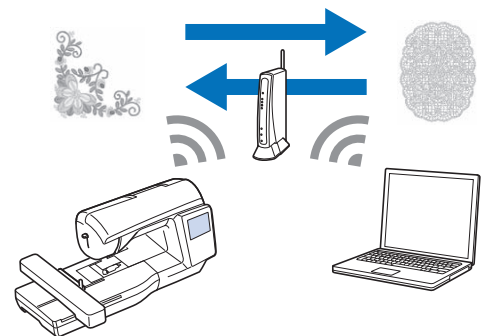

- Wirelessly transfer to the machine an embroidery pattern edited with embroidery editing software (PE-DESIGN version 11 or later) on a computer. Also, transfer to PE-DESIGN an embroidery pattern edited on the machine.
- * Settings must be specified in PE-DESIGN. For more information, refer to the manual for PE-DESIGN.



Enabling a wireless network connection

The machine can be connected to your wireless network.

- 1 Press  to display the settings screen.
- 2 Display page 12 by pressing  .
- 3 Set [Wireless LAN Enable] to [ON].



→ The machine prepares for wireless connection.

Requirements for a wireless network connection

The wireless network connection complies with IEEE 802.11 b/g/n standards and uses the 2.4 GHz frequency.

Memo

- A wireless network cannot be set up with WPA/WPA2 Enterprise.

Using the wizard to set up the wireless network connection

There are multiple ways to set up the wireless network connection. We recommend the method that uses the wizard on this machine.

- 1 In order to connect your machine to a wireless network, the security information (SSID and network key) for your home network will be required. The network key may also be called a password, security key or encryption key. Check your security information, and write it in the space below.

SSID	Network key (password)

Memo

- The wireless network connection cannot be set up if you do not have the security information.
- How to find the security information
 - ① Check the manual provided with your home network.
 - ② The default SSID may be the manufacturer's name or the model name.
 - ③ If you cannot find the security information, contact the manufacturer of the router, your network administrator or your Internet provider.
 - ④ Some SSIDs and network keys (passwords) may be case sensitive.

- 2 Press  beside [Wireless LAN Setup Wizard].

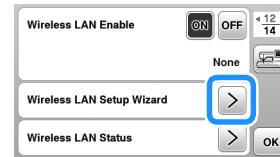



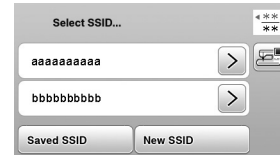

→ A list of available SSIDs appears.

- 3 Select the SSID that was noted.



→ The screen for entering the network key (password) appears.

Memo

- When displaying next or previous pages, press  or  key to search the SSID that was noted.
- If the desired SSID is not listed, specify it as described below.
 - ① Press  in the end of the SSID list.
 - ② Enter the desired SSID, and then press .
 - ③ Select the authentication method and encryption mode.
- If using a previous connection, press , and then select the saved SSID.

- 4 Enter the network key (password) that was noted, and then press .

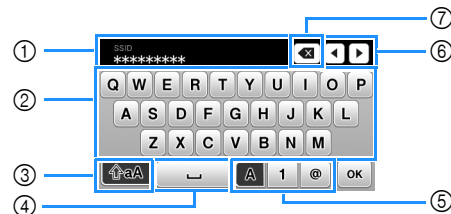

- ① Text input area
- ② Character keys
- ③ Caps key
- ④ Space key
- ⑤ Letters/numbers/symbols key
- ⑥ Cursor keys (Move the cursor to the left or right.)
- ⑦ Backspace key (Deletes the character at the cursor's position.)

- 5 When the following message appears, press **OK**.



→ When a connection is established, the following message appears.

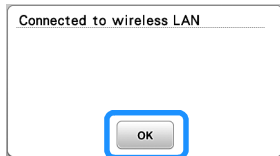

- 6 Press **OK** to exit the setup.



→ Use the [Machine name] on page 13 of the settings screen for the wireless LAN function.

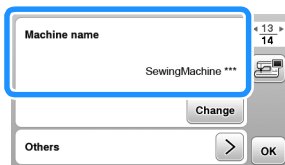

Memo

- While connected, the signal strength can be confirmed by the wireless LAN key in the lower right of the stitch or pattern type selection screen.

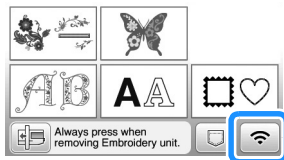
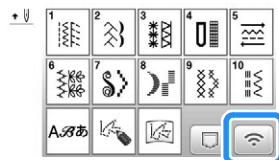

- Once a wireless network connection has been set up, a wireless network connection will be established each time the machine is turned on. However, [Wireless LAN Enable] in the wireless LAN settings screen must remain set to [ON].

Setting the wireless LAN connection from the [Others] menu

The [Others] menu on page 13 of the settings screen contains the following items.

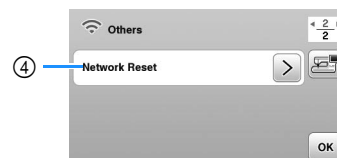
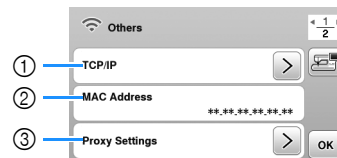
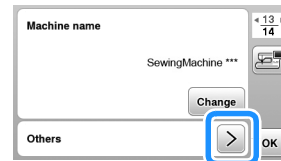

- ① TCP/IP settings can be manually entered.
- ② Shows the MAC address.
- ③ Use when proxy settings are required.
- ④ Resets the wireless LAN connection settings.

Winding/Installing the Bobbin

⚠ CAUTION

- Use the plastic bobbin that comes with this machine or bobbins of the same type. The bobbin's height is 11.5 mm (approx. 7/16 inch). SA156 is Class 15 type bobbin.

Winding the bobbin

This section describes how to wind thread onto a bobbin.

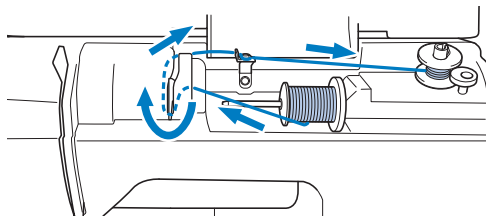

📖 Memo

- When winding the bobbin for sewing utility stitches, use thread appropriate for the fabric that you wish to sew (page 27). Normally, the thread will be the same as what is used for the upper threading.
- When winding bobbin for embroidery, be sure to use the recommended bobbin thread for this machine.

1 Open the top cover.

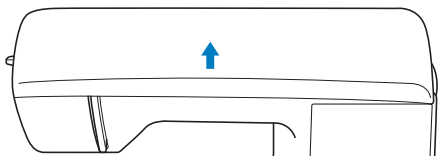

2 Place the bobbin on the bobbin winder shaft so that the notch in the bobbin aligns with the spring on the shaft, and then slide the bobbin winder shaft to the right until it snaps into place.

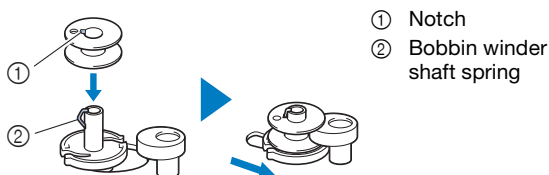

📖 Memo

- By placing the bobbin into the bobbin case in the same orientation that it was on the bobbin winder shaft, the bobbin can be installed with the correct winding direction of the bobbin thread.

The "b" mark on one side of the bobbin included with this machine can be used as a reference.

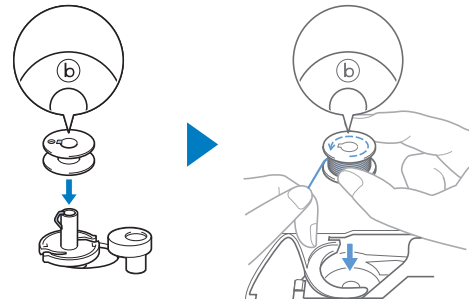

3 Remove the spool cap and place the spool of thread for the bobbin onto the spool pin.

Slide the spool onto the spool pin so that the thread unwinds to the front from the bottom. Otherwise the thread may become tangled around the spool pin.

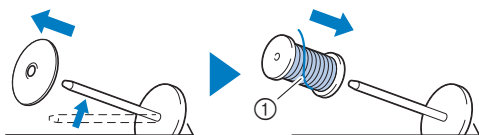

① The thread unwinds to the front from the bottom.

4 Slide the spool cap onto the spool pin.

Slide the spool cap as far as possible to the right, as shown, with the rounded side on the left.

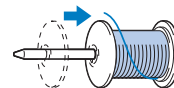

⚠ CAUTION

- If the spool or the spool cap is not installed correctly, the thread may become tangled around the spool pin, and the machine may be damaged.
- Three spool cap sizes are available, allowing you to choose a spool cap that best fits the size of spool being used. If the spool cap is too small for the spool being used, the thread may catch on the slit in the spool or the machine may be damaged. When using mini king thread spool, use the thread spool insert (mini king thread spool). For details on thread spool insert (mini king thread spool), refer to "Memo" on page 21.



Memo

- When using the spool as shown below, use the thread spool insert (mini king thread spool). Make sure that the thread spool insert is firmly inserted. After installing it, pull out some thread, and check that the thread unwinds without getting caught.

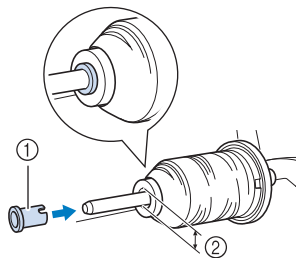

- ① Thread spool insert (mini king thread spool)
- ② Hole diameter 8.0 mm to 10.5 mm (5/16 inch to 13/32 inch)
- ③ Spool (cross-wound thread)

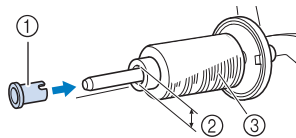

- When using thread that winds off quickly, such as transparent nylon thread or metallic thread, place the spool net over the spool before placing the spool of thread onto the spool pin. If the spool net is too long, fold it to fit the size of the spool.



- 5** While holding the thread near the spool, pass the thread through the thread guide cover. And then, pass the thread under the thread guide plate, and pull it to the right.

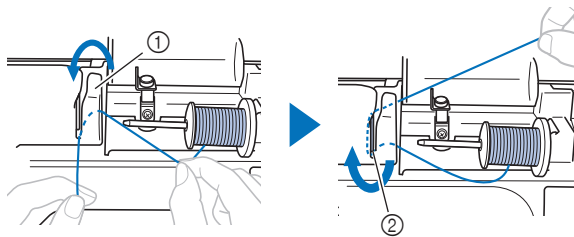

- ① Thread guide cover
- ② Thread guide plate

- 6** Pass the thread under the hook on the bobbin winding thread guide, and then wind it counterclockwise under the pretension disk.

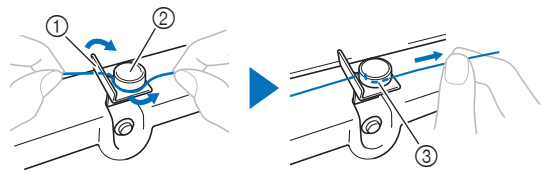

- ① Bobbin winding thread guide
- ② Pretension disk
- ③ Pull it in as far as possible

Note

- Make sure that the thread is passed under the pretension disk.

- 7** Wind the thread clockwise around the bobbin 5 or 6 times, pass the thread through the guide slit in the bobbin winder seat, and then pull the thread to cut it.

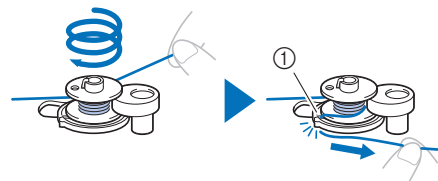

- ① Guide slit in bobbin winder seat (with built-in cutter)

Note

- Be sure to wind the thread clockwise around the bobbin, otherwise the thread will become wrapped around the bobbin winder shaft.

CAUTION

- Be sure to cut the thread as described. If the bobbin is wound without cutting the thread using the cutter built into the guide slit in the bobbin winder seat, the thread may become tangled in the bobbin or the needle may bend or break when the bobbin thread starts to run out.

- 8** Slide the sewing speed controller to adjust the bobbin winding speed. Slide the controller to the right to increase the speed; slide it to the left to reduce the speed.

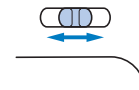

Memo

- We recommend winding stretch thread, such as transparent nylon thread, at a low speed since the thread may stretch.

- 9** Turn on the machine.

- The “Start/Stop” button lights up in orange.

- 10** Press the “Start/Stop” button to start winding the bobbin.
When the foot controller is plugged in, press down on the foot controller.

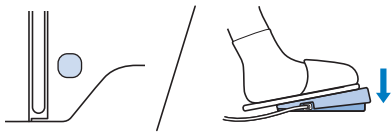

Note

- When winding transparent nylon thread on the bobbin, stop bobbin winding when the bobbin is 1/2 to 2/3 full. If the bobbin was fully wound with transparent nylon thread, it may not be wound neatly, or sewing performance may suffer. In addition, extreme pressure may be applied to the bobbin, it may not be possible to remove the bobbin from the bobbin winder shaft, or the bobbin may break.



- 11** When the bobbin winding becomes slow, press the “Start/Stop” button to stop the machine.
When the foot controller is plugged in, remove your foot from the foot controller.

CAUTION

- When the bobbin winding becomes slow, stop the machine, otherwise the machine may be damaged.

- 12** Cut the thread, slide the bobbin winder shaft to the left until it snaps into place, and then remove the bobbin.

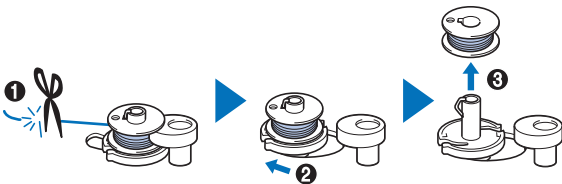

- 13** Slide the sewing speed controller to desired sewing speed position.
14 Remove the spool for the bobbin thread from the spool pin.

Installing the bobbin

Install the bobbin wound with thread.

You can begin sewing immediately without pulling up the bobbin thread by simply inserting the bobbin in the bobbin case and guiding the thread through the slit in the needle plate cover.

Memo

- If the threads will be pulled to create gathers or the thread at the beginning of sewing will be finished, for example, when free motion quilting, first pull up the bobbin thread.
For details, refer to “Pulling up the bobbin thread” on page 26.

CAUTION

- Use a bobbin that has been correctly wound with thread, otherwise the needle may break or the thread tension will be incorrect.





- Before inserting or changing the bobbin, be sure that you have pressed  on the operation panel to lock all keys and buttons, otherwise injuries may occur if the “Start/Stop” button or any other button is pressed and the machine starts.

- 1** Turn on the machine.

- 2** Press  (Needle position button) once or twice to raise the needle.

- 3** Press .

- When the message [OK to automatically lower the presser foot?] appears on the LCD screen, press  to continue.

→ The screen changes, and all keys and operation buttons are locked (except .

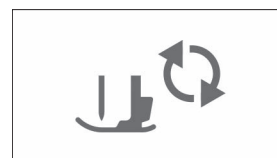

- 4** Raise the presser foot lever.

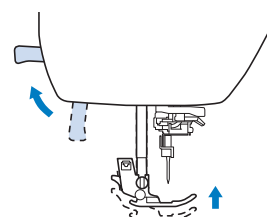

- 5 Slide the bobbin cover latch to the right and remove the bobbin cover.

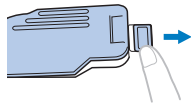

- 6 Insert the bobbin into the bobbin case so that the thread unwinds to the left.

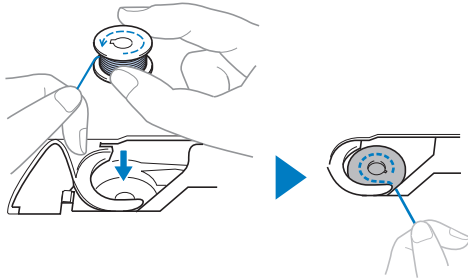

Memo

- For the correct winding direction of the bobbin thread, be sure to place the bobbin into the bobbin case in the same orientation that it was on the bobbin winder shaft.

The “b” mark on one side of the bobbin included with this machine can be used as a reference.

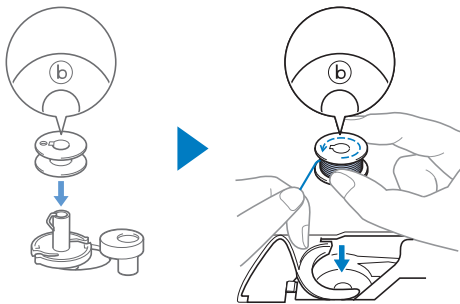

- 7 Lightly hold down the bobbin with your right hand (1), and then guide the end of the thread around the tab of the needle plate cover with your left hand (2).

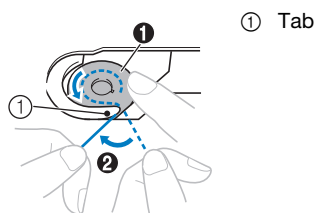

CAUTION

- Be sure to hold down the bobbin with your finger and unwind the bobbin thread correctly, otherwise the thread may break or the thread tension will be incorrect.

- 8 While lightly holding down the bobbin with your right hand (1), guide the thread through the slit in the needle plate cover (2) and lightly pull it with your left hand (3).

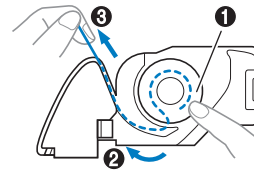

Memo

- By guiding the thread around the tab of the needle plate cover, passing the thread as shown by 2 in this illustration, then lightly pulling the thread at 3, the thread will enter the tension spring of the bobbin case to apply the appropriate tension to the bobbin thread during sewing.

- 9 While lightly holding down the bobbin with your right hand (1), continue guiding the thread through the slit with your left hand (2). Then, cut the thread with the cutter (3).

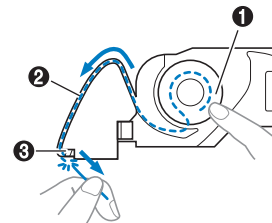

Memo

- Be sure to complete the bobbin threading correctly according to these instructions. If the thread is simply placed in the slit in the needle plate cover, the bobbin thread will not be correctly threaded, resulting in poor sewing performance or incorrect thread tension.

- 10 Reattach the bobbin cover.

Insert the tab of the bobbin cover into the notch of the needle plate cover, and then lightly press down on the right side.

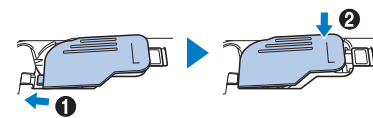

Memo

- You can begin sewing without pulling up the bobbin thread. If you wish to pull up the bobbin thread before starting to sew, pull up the thread according to the procedure in “Pulling up the bobbin thread” on page 26.

- 11 Press  to unlock all keys and buttons.

Upper Threading

⚠ CAUTION

- When threading the upper thread, carefully follow the instructions. If the upper threading is not correct, the thread may become tangled or the needle may bend or break.
- Never use a thread weight of 20 or lower.
- Use the needle and the thread in the correct combination. For details on the correct combination of needles and threads, refer to “Fabric/Thread/Needle Combinations” on page 27.

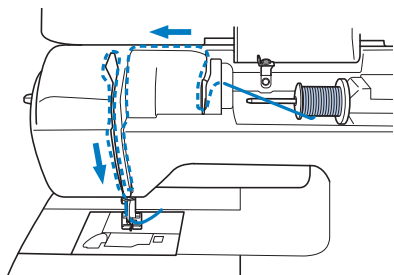

Threading the upper thread

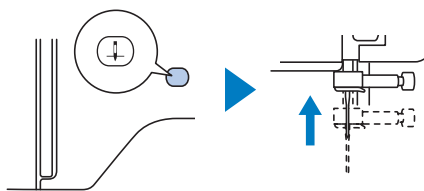

→ When threading the upper thread, carefully follow the instructions.

- 1 Turn on the machine.
- 2 Press  (Needle position button) once or twice to raise the needle.



- 3 Press .
 - When the message [OK to automatically lower the presser foot?] appears on the LCD screen, press  to continue.
 - The screen changes, and all keys and operation buttons are locked (except .

⚠ CAUTION

- When threading the needle, be sure that you have pressed  on the operation panel to lock all keys and buttons, otherwise injuries may occur if the “Start/Stop” button or any other button is pressed and the machine starts.

- 4 Raise the presser foot lever to raise the presser foot.

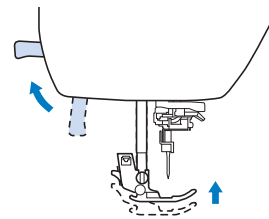

Memo

- If the presser foot is not raised, the machine cannot be threaded.

- 5 Remove the spool cap and place the spool of thread onto the spool pin.

Slide the spool onto the spool pin so that the thread unwinds to the front from the bottom. Otherwise the thread may become tangled around the spool pin.

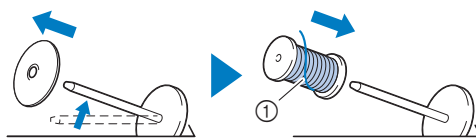

① The thread unwinds to the front from the bottom.

- 6 Slide the spool cap onto the spool pin.

Slide the spool cap as far as possible to the right, as shown, with the rounded side on the left.

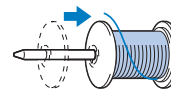

⚠ CAUTION

- Choose a spool cap that best fits the size of spool being used. For more information regarding the choice of spool caps for your thread choice, refer to “Memo” on page 21.

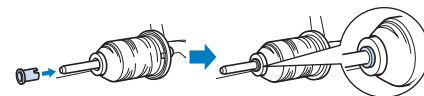

- If the spool or the spool cap is not positioned correctly, the thread may become tangled around the spool pin or the needle may break.

- 7** While holding the thread near the spool, pass the thread through the thread guide cover. And then, pass the thread under the thread guide plate, and pull it up.

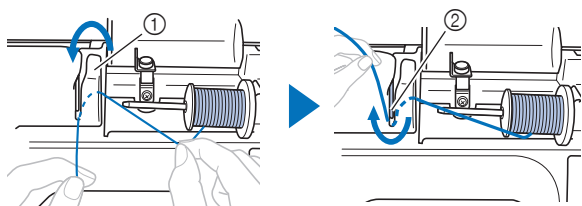

- ① Thread guide cover
② Thread guide plate

- 8** While holding the thread passed under the thread guide plate, pass the thread through the thread channel in the order shown below.

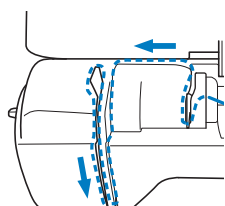

Note

- If the presser foot has been lowered and the shutter is closed, the machine cannot be threaded. Be sure to raise the presser foot to open the shutter before threading the machine. In addition, before removing the upper thread, be sure to raise the presser foot to open the shutter.
- This machine is equipped with a window that allows you to check the position of the take-up lever. Look through this window and check that the thread is correctly fed through the take-up lever.

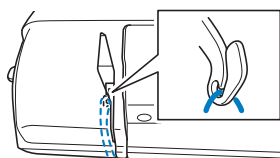

- 9** Slide the thread behind the needle bar thread guide.

The thread can easily be slid behind the needle bar thread guide by holding the thread in your left hand, then feeding the thread with your right hand, as shown. Make sure that the thread is passed through to the left of the tab of the needle bar thread guide.

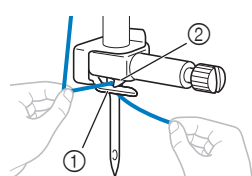

- ① Needle bar thread guide
② Tab

- 10** Check that the needle and thread are compatible with the needle threader. If they are compatible, continue with the next step.

- The needle threader can be used with machine needles 75/11 through 100/16.
- The needle threader cannot be used with the wing needle or the twin needle.
- When thread such as transparent nylon monofilament or specialty threads are used, it is not recommended to use the needle threader.
- If the needle threader cannot be used, insert the thread through the eye of the needle from front to back by hand. At this time, be sure to lock all keys and operation buttons described in step **3**.

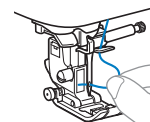

- 11** Pull the end of the thread, which has been passed through the needle bar thread guide, to the left, then pass the thread through the notch of the threader thread guide, and then firmly pull the thread from the front and insert it into the slit of the threader thread guide disk marked "7" all the way.

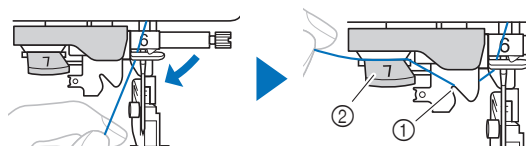

- ① Notch of the threader thread guide
② Threader thread guide disk

- 12** Lower the presser foot lever to lower the presser foot.

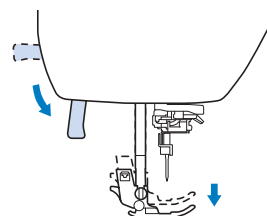

- 13** Cut the thread with the thread cutter on the left side of the machine.

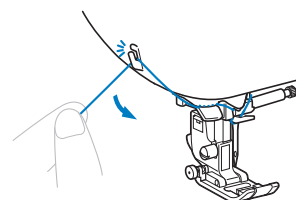

Note

- When using thread that quickly winds off the spool, such as metallic thread, it may be difficult to thread the needle if the thread is cut. Therefore, instead of using the thread cutter, pull out about 8 cm (approx. 3 inches) of thread after passing it through the threader thread guide disk (marked "7").

- 14** Lower the needle threader lever on the left side of the machine until it clicks, and then slowly return the lever to its original position.

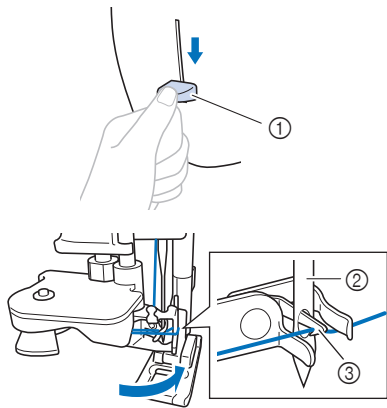

- ① Needle threader lever
- ② Needle
- ③ Hook

Note

- If the needle is not raised to its highest position, the needle threader cannot thread the needle. If the needle is not at the highest position, turn handwheel counterclockwise until the needle is at its highest position.

- 15** Carefully pull the end of thread that was passed through the eye of the needle.

If the needle was not completely threaded, but a loop in the thread was formed in the eye of the needle, carefully pull the loop through the eye of the needle to pull out the end of the thread.

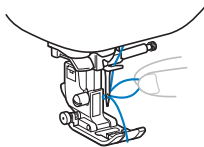

- 16** Raise the presser foot lever, pass the end of the thread through and under the presser foot, and then pull out about 10 cm (approx. 4 inches) of thread toward the rear of the machine.

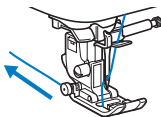



- 17** Press  to unlock all keys and buttons.

Pulling up the bobbin thread

If the threads will be pulled to create gathers or the thread at the beginning of sewing will be finished, for example, when free motion quilting, first pull up the bobbin thread.

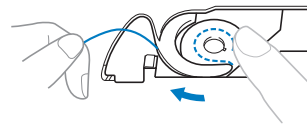
- 1** Refer to “Threading the upper thread” on page 24 to thread the machine with the upper thread and thread the needle.
- 2** Follow steps **1** to **6** “Installing the bobbin” on page 22 for installing the bobbin and to insert the bobbin into the bobbin case.
- 3** Pass the bobbin thread through the slot.
Do not cut the thread with the cutter, otherwise it will be difficult to pull up the bobbin thread.



- 4** Press  to unlock all keys and buttons.
- 5** While lightly holding the upper thread with your left hand, press  (Needle position button) twice to lower and then raise the needle.

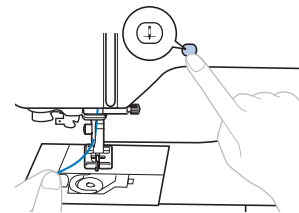

→ The bobbin thread is looped around the upper thread and can be pulled up.

- 6** Carefully pull the upper thread upward to pull out the end of the bobbin thread.

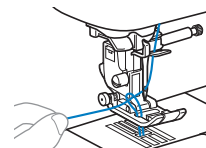

- 7** Pull up the bobbin thread, pass it under the presser foot and pull it about 10 cm (4 inches) toward the back of the machine, making it even with the upper thread.

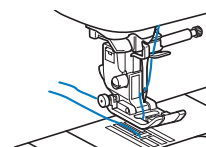

- 8** Reattach the bobbin cover.

Fabric/Thread/Needle Combinations

- **Needles that can be used with this machine: Home sewing machine needles (size 65/9 - 100/16)**
* The larger the number, the larger the needle. As the numbers decrease, the needles get finer.
- **Thread that can be used with this machine: 30 - 90 weight**
* Never use thread of 20 weight or lower. It may cause machine to malfunction.
* The smaller the number, the heavier the thread. As the numbers increase, the thread gets finer.
- **The machine needle and thread that should be used depends on the type and thickness of the fabric. Refer to the following table when choosing the thread and needle appropriate for the fabric that you wish to sew.**
 - The combinations shown in the table provide a general guideline. Be sure to sew trial stitches on the actual number of layers and type of fabric to be used in your project.
 - The machine needles are consumables. For safety and best results, we recommend replacing the needle regularly. For details on when to replace the needle, refer to "Checking the needle" on page 28.
- **In principle, use a fine needle and thread with lightweight fabrics, and a larger needle and heavier thread with heavyweight fabrics.**
- **Select a stitch appropriate for the fabric, and then adjust the stitch length. When sewing lightweight fabrics, make the stitch length finer (shorter). When sewing heavyweight fabrics, make the stitch length coarser (longer). (page 38)**
When sewing stretch fabrics, refer to "Sewing stretch fabrics" on page 42.

Fabric Type/Application		Thread		Size of needle	Stitch length mm (inch)
		Type	Weight		
Lightweight fabrics	Lawn, georgette, challis, organdy, crepe, chiffon, voile, gauze, tulle, lining, etc.	Polyester thread	60 - 90	65/9 - 75/11	Fine stitches 1.8-2.5 (1/16-3/32)
		Cotton thread, Silk thread	50 - 80		
Medium weight fabrics	Broadcloth, taffeta, gabardine, flannel, seersucker, double gauze, linen, terry cloth, waffle weave, sheeting, poplin, cotton twill, satin, quilting cotton, etc.	Polyester thread	60 - 90	75/11 - 90/14	Regular stitches 2.0-3.0 (1/16-1/8)
		Cotton thread, Silk thread	50 - 60		
Heavyweight fabrics	Denim (12 ounces or more), canvas, etc.	Polyester thread, Cotton thread	30	100/16	Coarse stitches 2.5-4.0 (3/32-3/16)
		Polyester thread	60	90/14 - 100/16	
	Cotton thread, Silk thread	30 - 50			
Stretch fabrics (knit fabrics, etc.)	Jersey, tricot, T-shirt fabric, fleece, interlock, etc.	Polyester thread, Cotton thread, Silk thread	50	Ball point needle 75/11 - 90/14	Setting appropriate for the fabric thickness
For top-stitching		Polyester thread, Cotton thread	30	90/14 - 100/16	Setting appropriate for the fabric thickness
			50 - 60	75/11 - 90/14	

■ Transparent nylon thread

Use a home sewing machine topstitching needle, regardless of the fabric or thread.

■ Sewing character stitch patterns and decorative stitch patterns (needles and threads)

When sewing lightweight, medium weight or stretch fabrics, use a ball point needle (gold colored) 90/14. When sewing heavyweight fabrics, use a home sewing machine needle 90/14. In addition, #50 to #60 thread should be used.

■ Embroidery needles

Use a 75/11 home sewing machine needle for embroidery.

⚠ CAUTION

- The appropriate fabric, thread and needle combinations are shown in the preceding table. If the combination of the fabric, thread and needle is not correct, particularly when sewing heavy fabrics (such as denim) with thin needles (such as 65/9 to 75/11), the needle may bend or break. In addition, the stitching may be uneven or puckered or there may be skipped stitches.

Replacing the Needle

⚠ CAUTION

- Only use recommended home sewing machine needles. Use of any other needle may bend the needle or damage the machine.
- Never use bent needles. Bent needles can easily break, possibly resulting in injuries.

Checking the needle

Before using the needle, place the flat side of the needle on a flat surface and check that the distance between the needle and the flat surface is even.

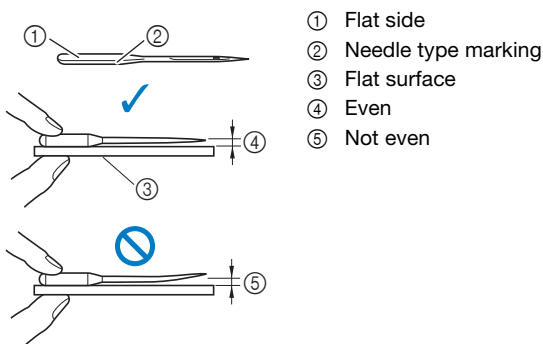

Note

- The machine needles are consumables. Replace the needle in cases such as those described below.
 - If an unusual sound is produced when the needle enters the fabric. (The tip of the needle may be broken or dull.)
 - If stitches are skipped. (The needle may be bent.)
 - Generally, after completing one project, such as a piece of clothing.

Replacing the needle

Use the screwdriver and a new needle that has been determined to be straight according to the instructions in "Checking the needle" on page 28.

- 1 Press (Needle position button) once or twice to raise the needle.
- 2 Place fabric or paper under the presser foot to cover the hole in the needle plate to prevent the needle from falling into the machine.
- 3 Press .
 - When the message [OK to automatically lower the presser foot?] appears on the LCD screen, press to continue.

→ The screen changes, and all keys and operation buttons are locked (except).

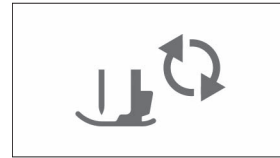

⚠ CAUTION

- When replacing the needle, be sure that you have pressed on the operation panel to lock all keys and buttons, otherwise injuries may occur if the "Start/Stop" button or any other button is pressed and the machine starts.

- 4 Follow steps 3 to 4 "Replacing the presser foot" on page 29 for removing the presser foot.

- 5 Hold the needle with your left hand, and then use a screwdriver to turn the needle clamp screw toward you (counterclockwise) to remove the needle.

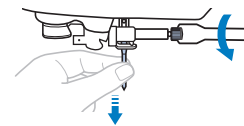

- Do not apply a strong force when loosening or tightening the needle clamp screw, otherwise certain parts of the machine may be damaged.

- 6 With the flat side of the needle toward the rear of the machine, insert the new needle until it touches the needle stopper. Using the screwdriver tighten the needle clamp screw by turning it clockwise.

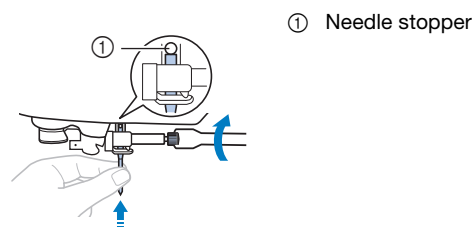

⚠ CAUTION

- Be sure to insert the needle until it touches the needle stopper and securely tighten the needle clamp screw with the screwdriver, otherwise the needle may break or damage may result.

- 7 Follow steps 5 to 7 "Replacing the presser foot" on page 29 for reattaching the presser foot.

- 8 Press to unlock all keys and buttons.

Replacing the Presser Foot

! CAUTION

- Use the appropriate presser foot for the type of stitch that you wish to sew, otherwise the needle may hit the presser foot, causing the needle to bend or break. For details on the presser foot that should be used with the selected stitch, refer to “Stitch Chart” on page 45.
- Use presser feet designed specifically for this machine.

Note

- When a stitch is selected, the icon for the presser foot that should be used appears in the screen. Check that the correct presser foot is attached before starting to sew. If the wrong presser foot is installed, attach the appropriate presser foot. (page 13)

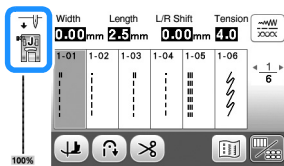

Replacing the presser foot

- 1 Press (Needle position button) once or twice to raise the needle.
- 2 Press .
 - When the message [OK to automatically lower the presser foot?] appears on the LCD screen, press to continue.
 - The screen changes, and all keys and operation buttons are locked (except).

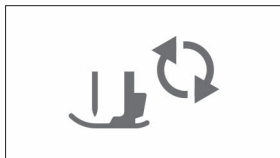

! CAUTION

- When replacing the presser foot, be sure that you have pressed on the operation panel to lock all keys and buttons, otherwise injuries may occur if the “Start/Stop” button or any other button is pressed and the machine starts.

1 GETTING READY

- 3 Raise the presser foot lever.
- 4 Press the black button at the back of the presser foot holder in order to remove the presser foot.

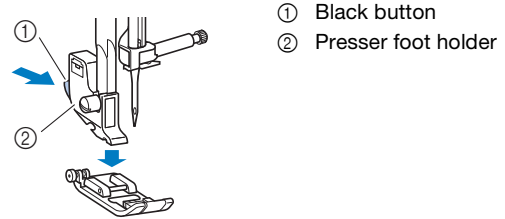

- 5 Place the appropriate presser foot below the presser foot holder so that the presser foot pin is aligned with the notch in the holder.

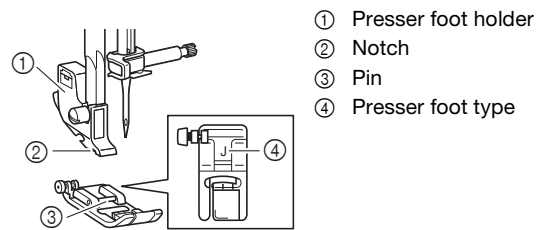

- 6 Slowly lower the presser foot lever so that the presser foot pin snaps into the notch in the presser foot holder.

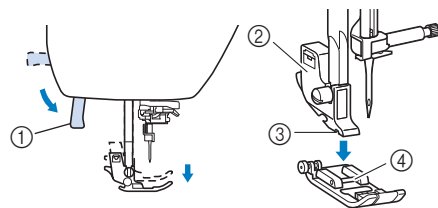

- 7 Raise the presser foot lever to check that the presser foot is securely attached.

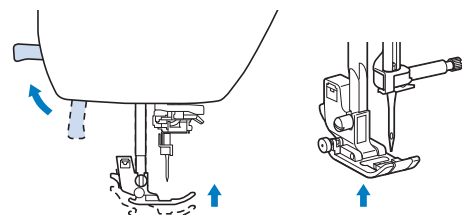



- 8 Press to unlock all keys and buttons.

Removing and attaching the presser foot holder

Remove the presser foot holder when cleaning the machine or when installing a presser foot that does not use the presser foot holder, such as the walking foot and Free motion open toe quilting foot "O".

■ Removing the presser foot holder

- 1 Press .
 - When the message [OK to automatically lower the presser foot?] appears on the LCD screen, press  to continue.
 - The screen changes, and all keys and operation buttons are locked (except .

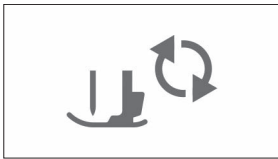

- 2 **Remove the presser foot.**
 - For details, refer to "Replacing the presser foot" on page 29.
- 3 **Use the screwdriver to loosen the presser foot holder screw.**

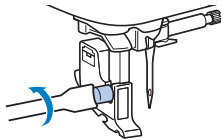

Turn the screw toward the back of the machine (counterclockwise).



- The presser foot holder screw can also be loosened or tightened with the disc-shaped screwdriver.

- 4 Press  to unlock all keys and buttons.

■ Attaching the presser foot holder

- 1 Press .
 - When the message [OK to automatically lower the presser foot?] appears on the LCD screen, press  to continue.
 - The screen changes, and all keys and operation buttons are locked (except .

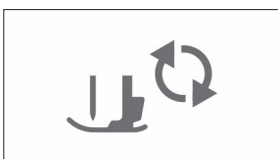

- 2 **Raise the presser foot lever.**
- 3 **Align the notch in the presser foot holder with the screw.**

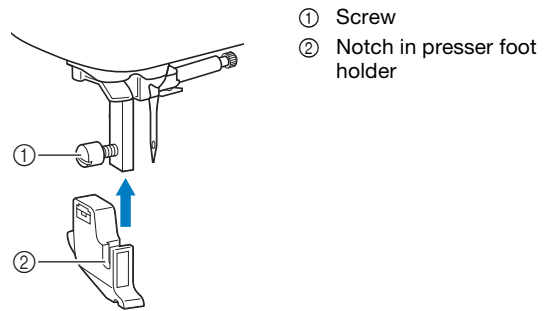

- 4 **Hold the presser foot holder in place with your right hand, and then tighten the screw using the screwdriver in your left hand.**

Turn the screw toward you (clockwise).

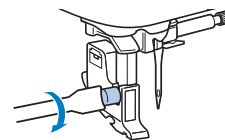

⚠ CAUTION

- Be sure to securely tighten the presser foot holder screw, otherwise the presser foot holder may fall off and the needle may strike it, causing the needle to bend or break.

- 5 Press  to unlock all keys and buttons.

Chapter 2 SEWING BASICS

Sewing

⚠ CAUTION

- While the machine is in operation, pay special attention to the needle location. In addition, keep your hands away from all moving parts such as the needle and handwheel, otherwise injuries may occur.
- Do not pull or push the fabric too hard while sewing, otherwise injuries may occur or the needle may break.
- Never use bent needles. Bent needles can easily break, possibly resulting in injuries.
- Make sure that the needle does not strike basting pins, otherwise the needle may break or bend.

Stitch types

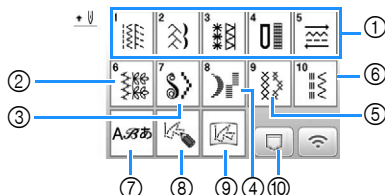

- Utility stitches (page 45)
You can select from utility stitches, including straight line stitching, overcasting, buttonhole and basic decorative stitches.
- Decorative stitches
- Satin stitches
- 7 mm satin stitches
- Cross stitch stitches
- Utility decorative stitches
- Character stitches
- MY CUSTOM STITCH (page 76)
You can design original stitch patterns.
- MY CUSTOM STITCH stored in the machine's memory or USB flash drive (page 77)
- Stitch patterns stored in the machine's memory or USB flash drive (page 75)

Basic sewing

Note

- First, perform a trial sewing, using a piece of fabric and thread that are the same as those used for your project.

- Prepare the appropriate needle and thread for the type of fabric. (page 27)
If necessary, replace the needle. (page 28)
- Wind thread onto a bobbin, and then install it into the machine. (page 20)
- Thread the upper thread. (page 24)
- Press  on the operation panel and select the stitch type.
- Select a stitch.

◀ displays the previous screen, and ▶ displays the next screen.

- For details on the key functions, refer to “Viewing the LCD” on page 13.
- If necessary, change to the desired stitch width or stitch length. (page 38)

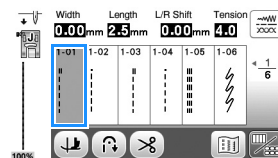

- Check which presser foot is indicated in the upper-left corner of the screen, and then attach it. Attach zigzag foot “J” in this example. (It is on the machine when purchased.)

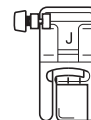

- For details on changing the presser foot, refer to “Replacing the Presser Foot” on page 29.

⚠ CAUTION

- Always use the correct presser foot. If the wrong presser foot is used, the needle may strike the presser foot and bend or break, possibly resulting in injury or damage to the machine. Refer to “Stitch Chart” on page 45 for presser foot recommendations.

- 7** Set the fabric under the presser foot. Hold the fabric and thread with your left hand, and rotate the handwheel counterclockwise or press  (Needle position button) to set the needle in the sewing start position.

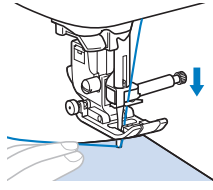

- 8** Press  (Presser foot lifter button) to lower the presser foot.

- 9** Adjust the sewing speed with the sewing speed controller. (when using utility stitches)

You can use this controller to adjust sewing speed during sewing.



- 10** Press the “Start/Stop” button to start sewing. (When the foot controller is plugged in, slowly press down on the foot controller.)

Guide the fabric lightly by hand.

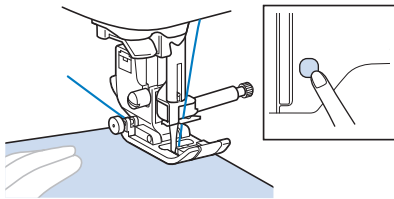

Memo

- When the foot controller is connected, the “Start/Stop” button cannot be used to start sewing.

- 11** Press the “Start/Stop” button again to stop sewing. (When the foot controller is plugged in, remove your foot from the foot controller.)

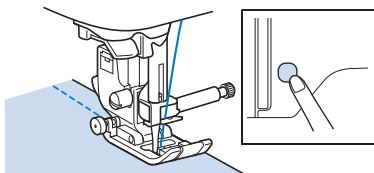

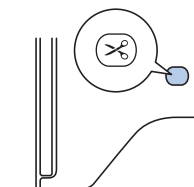

- 12** Press  (Thread cutter button) to trim the upper and bobbin threads.



→ The needle will return to the up position automatically.

CAUTION

- Do not press  (Thread cutter button) after the threads have been cut. Doing so could tangle the thread or break the needle and damage the machine.
- Do not press  (Thread cutter button) when there is no fabric set in the machine. The thread may tangle, possibly resulting in damage.

Note

- When cutting thread such as nylon monofilament thread, or other decorative threads, use the thread cutter on the left side of the machine.

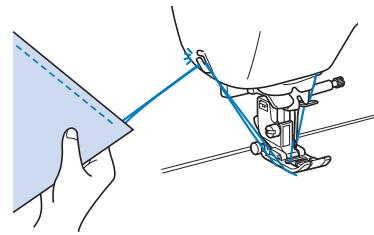

- 13** When the needle has stopped moving, press  (Presser foot lifter button) to raise the presser foot and remove the fabric.

- 14** Check the sewing finish. If necessary, adjust the thread tension. (page 38)

Using the foot controller

You can also use the foot controller to start and stop sewing.

Note

- (For U.S.A. only) Foot controller: Model T
This foot controller can be used on the machine with product code 888-G26/G30/G32/G34. The product code is mentioned on the machine rating plate.

Memo

- When the foot controller is connected, you cannot use the “Start/Stop” button.
- Bobbin winding can be started and stopped with the foot controller.
- The foot controller cannot be used when embroidering.

- 1** Turn off the machine.

2 Insert the foot controller plug into the foot controller jack on the machine.

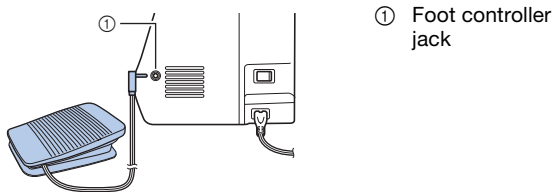

① Foot controller jack

3 Turn on the machine.

4 Slowly depress the foot controller to start sewing.

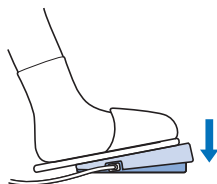

Memo

- The speed set with the sewing speed controller is the foot controller's maximum sewing speed.

5 Release the foot controller to stop sewing.

Combining stitch patterns

Stitch patterns from the following categories can be combined.

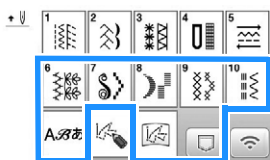

Example:



1 Press



2 Select the following stitch pattern.

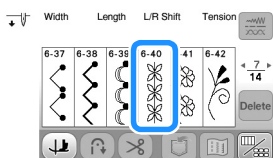

3 Press

→ The display returns to the stitch selection screen.

4 Press

5 Select a font.

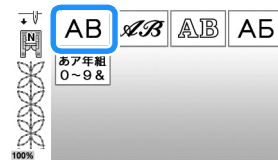

6 Press a tab to change the selection screens and enter a character.

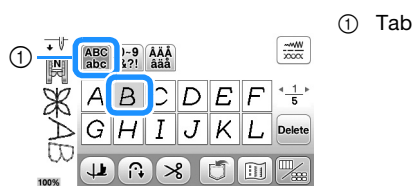

- To delete the character, press .
- To enter a space, press .

7 If you want to sew the stitch pattern continuously,

press to display editing screen, and then press

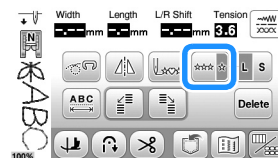

→ The stitch pattern turns continuous.

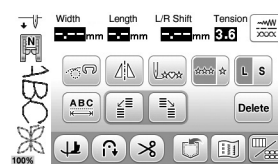

Memo

- When sewing is completed, trim any excess thread between characters.



Sewing reverse/reinforcement stitches

Reverse/reinforcement stitches are generally necessary at the beginning and end of sewing.

With reinforcement stitches, 3 to 5 stitches are sewn at the same place. With reverse stitches, the stitching is sewn in the opposite direction.

Depending on the selected stitch, reverse or reinforcement stitches are sewn while  (Reverse stitch button) is pressed continuously.

Memo



- When a reverse stitch pattern or reinforcement stitch pattern is selected, pressing  (Reverse stitch button) continuously will sew reverse stitches.

When any other stitch is selected, pressing  (Reverse stitch button) continuously will sew reinforcement stitches.

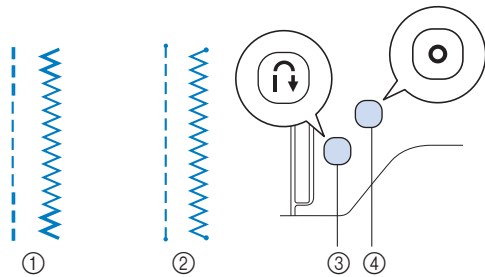

For details, refer to “Stitch Chart” on page 45.

- Pressing  (Reinforcement stitch button) continuously sews 3 to 5 stitches at the same place when any stitch pattern is selected.



- ① Reverse stitch
- ② Reinforcement stitch
- ③  (Reverse stitch button)
- ④  (Reinforcement stitch button)

Memo

- While pressing  (Reinforcement stitch button) when sewing character/decorative stitch pattern, you can stop sewing with one stitch pattern completed instead of at the midpoint of a stitch pattern.
- The green LED beside  (Reinforcement stitch button) lights up while a stitch is being sewn. The LED goes off when sewing of the reinforcement stitch is finished.

Automatic reverse/reinforcement stitching

After selecting a stitch pattern, turn on the automatic reverse/reinforcement stitching function before sewing, and the machine will automatically sew reinforcement stitches (or reverse stitches, depending on the stitch pattern) at the beginning and end of sewing.

1 Select a stitch.

- For details on selecting a stitch, refer to “Basic sewing” on page 31.

2 Press to set the automatic reverse/reinforcement stitching function.

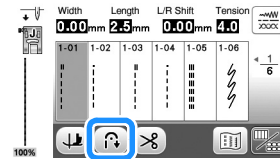

→ The key will display as .

3 Set the fabric in the start position and press the “Start/Stop” button to start sewing.

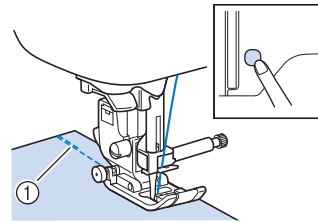

- ① Reverse stitches (or reinforcement stitches)

→ The machine will automatically sew reverse stitches (or reinforcement stitches) and then continue sewing.

Memo

- You can pause or resume sewing by pressing “Start/Stop” button while sewing.



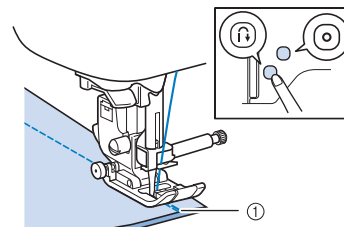

4 Once you have reached the end of the stitching, press (Reverse stitch button) or (Reinforcement stitch button).



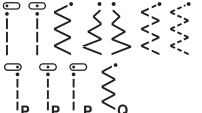

- ① Reverse stitches (or reinforcement stitches)

→ The machine will sew reverse stitches (or reinforcement stitches) and stop.

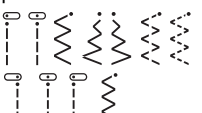
The operation performed when either of these buttons is pressed differs depending on the selected stitch pattern. Refer to the following table for details on the operation that is performed when the button is pressed.

	Reverse stitch button 	Reinforcement stitch button 
When the automatic reverse/reinforcement stitching function is not active with a reverse stitch pattern selected: 	Machine sews reverse stitches while holding the button.	Machine sews 3 - 5 reinforcement stitches while holding the button.
When the automatic reverse/reinforcement stitching function is not active with a reinforcement stitch pattern selected: 	Machine sews reverse stitches while holding the button.*	Machine sews 3 - 5 reinforcement stitches while holding the button.
When the automatic reverse/reinforcement stitching function is not active with a utility stitch other than reverse or reinforcement stitch pattern selected.	Machine sews 3 - 5 reinforcement stitches while holding the button.	Machine sews 3 - 5 reinforcement stitches while holding the button.
When the automatic reverse/reinforcement stitching function is not active with a character/decorative stitch pattern selected.	Machine sews 3 - 5 reinforcement stitches while holding the button.	Machine sews 3 - 5 reinforcement stitches after completing the stitch pattern, when the button is pressed.
When the automatic reverse/reinforcement stitching function is active with a reverse stitch pattern selected: 	Machine sews reverse stitches and stops sewing when the button is pressed. (At the beginning of sewing, reverse stitches are sewn automatically when "Start/Stop" button is pressed.)	Machine sews 3 - 5 reinforcement stitches and stops sewing when the button is pressed. (At the beginning of sewing, reverse stitches are sewn automatically when "Start/Stop" button is pressed.)
When the automatic reverse/reinforcement stitching function is active with a reinforcement stitch pattern selected: 	Machine sews reverse stitches and stops sewing when the button is pressed.* (At the beginning of sewing, reinforcement stitches are sewn automatically when "Start/Stop" button is pressed.)	Machine sews 3 - 5 reinforcement stitches and stops sewing when the button is pressed. (At the beginning of sewing, reinforcement stitches are sewn automatically when "Start/Stop" button is pressed.)

	Reverse stitch button 	Reinforcement stitch button 
When the automatic reverse/reinforcement stitching function is active with a utility stitch other than reverse or reinforcement stitch pattern selected.	Machine sews 3 - 5 reinforcement stitches and stops sewing when the button is pressed. (At the beginning of sewing, reinforcement stitches are sewn automatically when "Start/Stop" button is pressed.)	Machine sews 3 - 5 reinforcement stitches and stops sewing when the button is pressed. (At the beginning of sewing, reinforcement stitches are sewn automatically when "Start/Stop" button is pressed.)
When the automatic reverse/reinforcement stitching function is active with a character/decorative stitch pattern selected.	Machine sews 3 - 5 reinforcement stitches and stops sewing when the button is pressed. (At the beginning of sewing, reinforcement stitches are sewn automatically when "Start/Stop" button is pressed.)	Machine sews 3 - 5 reinforcement stitches and stops sewing after completing the stitch pattern, when the button is pressed. (At the beginning of sewing, reinforcement stitches are sewn automatically when "Start/Stop" button is pressed.)

* If [Reinforcement Priority] in the settings screen is set to [ON], reinforcement stitches are sewn instead of reverse stitches.

Memo

- Some stitches, such as buttonholes and bar tacks, require reinforcement stitches at the beginning of sewing. If you select one of these stitches, the machine will automatically turn on this function ( appears on the LCD when the stitch is selected).

Automatic thread cutting

The machine can be set to automatically cut the threads at the end of the stitching. If automatic thread cutting is set, automatic reverse/reinforcement stitching is also set.

If the machine is turned off, automatic thread cutting will be turned off.

1 Turn on the machine.

2 Select a stitch.

- For details on selecting a stitch, refer to "Basic sewing" on page 31.

3 Press  on the screen.

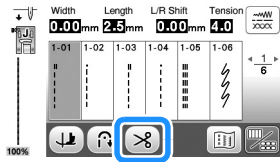



→ You get , and the machine is set for automatic thread cutting and automatic reverse/reinforcement stitching.

- To turn automatic thread cutting off, press .

4 Set the fabric in place, and press the “Start/Stop” button once.



→ Stitching will begin after reverse stitches (or reinforcement stitches) are sewn automatically.

5 Once you have reached the end of the stitching, press  (Reverse stitch button) or  (Reinforcement stitch button).

If stitching, such as buttonholes and bar tacking, that includes reinforcement stitching has been selected, this operation is unnecessary.

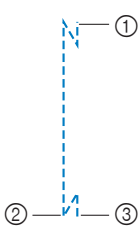
→ After the reverse stitching (or reinforcement stitching) has been done, the machine stops, and the threads are cut.





- ① The point where the “Start/Stop” button was pressed.
- ② The point where  (Reverse stitch button) or  (Reinforcement stitch button) was pressed.
- ③ The threads are cut here.

Automatic presser foot lowering function

By setting the machine to automatically raise and lower the presser foot, sewing operations can be performed more smoothly.

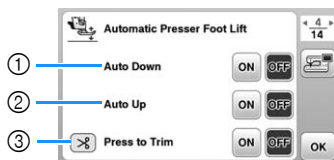
1 Press  to select the settings. (page 15)



- ① When set to [ON], pressing the “Start/Stop” button or depressing the foot controller automatically lowers the presser foot (if it is raised) before starting to sew.
- ② When set to [ON], the presser foot is raised when stopping sewing.
The presser foot is raised to the height specified for [Presser Foot Height] (page 2 of the settings screen). When the pivot setting is selected, the presser foot is raised to the height specified for [Pivoting Height] (page 3 of the settings screen).
- ③ When set to [ON], pressing the  (Thread cutter button) automatically lowers the presser foot (if it is raised) before cutting the thread. The presser foot will be raised after the thread is cut.

Automatic fabric sensor system (Automatic presser foot pressure)

The thickness of the fabric is automatically detected and the presser foot pressure is automatically adjusted with an internal sensor while sewing, to insure that your fabric is fed smoothly. The fabric sensor system works continuously while sewing. This function is useful for sewing heavyweight fabrics, or quilting (page 15).

1 Press , and then set [Automatic Fabric Sensor System] to [ON]. (page 15)

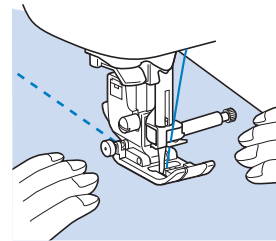
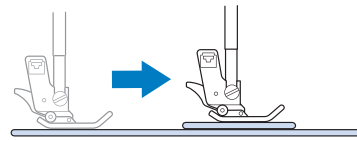



Pivoting

If the pivot key is selected, the machine stops with the needle lowered (in the fabric) and the presser foot is automatically raised to an appropriate height when the "Start/Stop" button is pressed. When the "Start/Stop" button is pressed again, the presser foot is automatically lowered and sewing continues. This function is useful for stopping the machine to rotate the fabric.

⚠ CAUTION



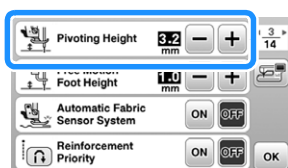

- When the pivot key is selected, the machine will begin stitching when the "Start/Stop" button is pressed or the foot controller is pressed down even if the presser foot has been raised by pressing  (Presser foot lifter button). Be sure to keep your hands and other items away from the needle, otherwise injuries may occur.

Memo

- When the pivot key is selected, the height of the presser foot when sewing is stopped can be changed according to the type of fabric being sewn. Press  to display [Pivoting Height] in the settings screen. Press  or  to select the height.



Note

- The [Needle Position - Up / Down] in the settings screen, must be set to the down position  for the pivot function to be used. When [Needle Position - Up / Down] is set in the raised position, the pivot function cannot be used.
- If  appears as light gray when the stitch pattern was selected, the pivot function cannot be used.
- Use  (Presser foot lifter button) to make sure the presser foot is lowered, and then press the [Start/Stop] button to continue sewing.
- If the pivot key is selected,  and  beside [Presser Foot Height] in the settings screen are not available and the setting cannot be changed.

- 1 Select a stitch.

- 2 Press  to select the pivot function.

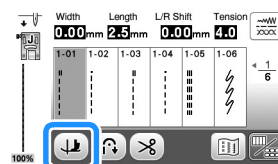

→ The key appears as .

- 3 Set the fabric in the start position, lower the presser foot and needle, and then press the "Start/Stop" button to start sewing.

- 4 Press the "Start/Stop" button to stop the machine at the point where the sewing direction changes.

→ The machine stops with the needle in the fabric, and the presser foot is raised.

- 5 Rotate the fabric, and then press the "Start/Stop" button.

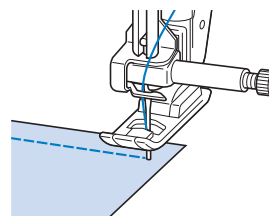



→ The presser foot is automatically lowered, and sewing continues.

Setting the stitch width/stitch length/“L/R Shift”

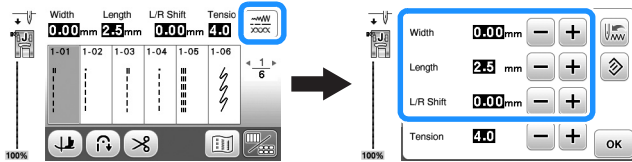



This machine is preset with the default settings for the stitch width, stitch length and “L/R Shift” for each stitch. However, you can change any of the settings by pressing  in the utility stitch screen.



After changing the settings, press  to return to the utility stitch screen.

If you wish to save specific settings for a stitch so that they can be used later, press  after changing the settings to save the new settings with the selected stitch.

Memo

- Press  to return the setting to its default. If  is then pressed, the default settings are saved to the machine instead of the former settings.
- If the straight stitch or triple stretch stitch was selected, changing the stitch width changes the needle position. Increasing the width moves the needle to the right; reducing the width moves the needle to the left. (page 38)
-  or  means the setting cannot be changed.

CAUTION

- After adjusting the stitch width or the “L/R Shift”, slowly turn the handwheel toward you (counterclockwise) and check that the needle does not touch the presser foot. If the needle hits the presser foot, the needle may bend or break.
- If the stitches are bunched together, increase the stitch length. Continuing to sew with the stitches bunched together may result in the needle bending or breaking.

Setting the stitch width

The stitch width (zigzag width) can be adjusted to make the stitch wider or narrower.

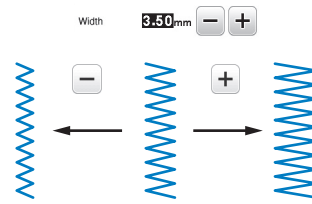

Setting the stitch length

The stitch length can be adjusted to make the stitch coarser (longer) or finer (shorter).

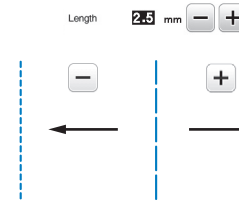

Setting the “L/R Shift”

The placement of the zigzag stitch can be adjusted to move the stitch to the right or left.

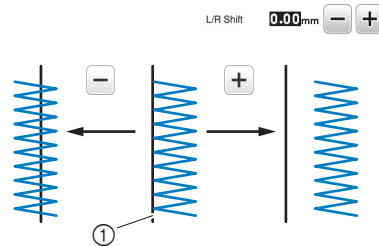

① Placement of the stitch pattern

Adjusting the Thread Tension

You may need to change the thread tension, depending on the fabric and thread being used.

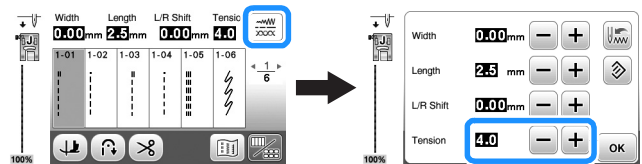

Correct thread tension

The upper thread and the bobbin thread should cross near the center of the fabric. Only the upper thread should be visible from the right side of the fabric, and only the bobbin thread should be visible from the wrong side of the fabric.

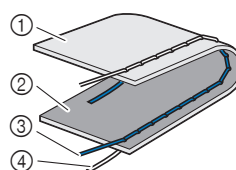

- ① Wrong side of fabric
- ② Right side of fabric
- ③ Upper thread
- ④ Bobbin thread

■ Upper thread is too tight

If the bobbin thread is visible from the right side of the fabric, the upper thread is too tight. Loosen the thread tension.

💡 Note

- If the bobbin thread was incorrectly threaded, the upper thread may be too tight. In this case, refer to “Installing the bobbin” on page 22 and rethread the bobbin thread.

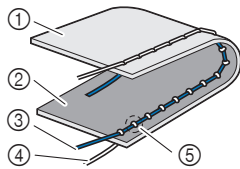

- ① Wrong side of fabric
- ② Right side of fabric
- ③ Upper thread
- ④ Bobbin thread
- ⑤ The bobbin thread is visible from the right side of the fabric.

Each press of **-** makes the thread tension looser.

■ Upper thread is too loose

If the upper thread is visible from the wrong side of the fabric, the upper thread is too loose. Tighten the thread tension.

💡 Note

- If the upper thread was incorrectly threaded, the upper thread may be too loose. In this case, refer to “Upper Threading” on page 24 and rethread the upper thread.

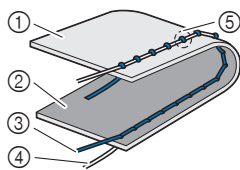

- ① Wrong side of fabric
- ② Right side of fabric
- ③ Upper thread
- ④ Bobbin thread
- ⑤ The upper thread is visible from the wrong side of the fabric.

Each press of **+** makes the thread tension tighter.

💡 Note

- If the upper thread is not threaded correctly or the bobbin is not installed correctly, it may not be possible to set the correct thread tension. If the correct thread tension cannot be achieved, rethread the upper thread and insert the bobbin correctly.

Useful Sewing Tips

Sewing tips

■ Trial sewing

Before starting your sewing project, we recommend sewing trial stitches using thread and scrap fabric that are the same as those used for your project.

While checking the sewing results, adjust the thread tension as well as the stitch length and width according to the number of fabric layers and stitch that is sewn.

💡 Note

- Other factors, such as fabric thickness, stabilizer material, etc., also have an effect on the stitch, so you should always sew a few trial stitches before beginning your project.
- When sewing satin stitch or 7 mm satin stitch patterns, there may be shrinking or bunching of stitches, so be sure to use a stabilizer material.

■ Changing the sewing direction

1 When the stitching reaches a corner, stop the machine.

Leave the needle lowered (in the fabric). If the needle remains up when the machine stops sewing, press **⬇** (Needle position button) to lower the needle.

2 Raise the presser foot lever, and then turn the fabric.

Turn the fabric using the needle as a pivot.

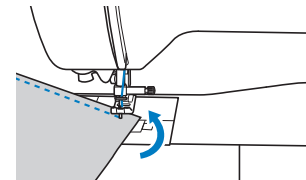

3 Lower the presser foot lever and continue sewing.

■ Sewing curves

Sew slowly while slightly changing the sewing direction to sew around the curve. For details on sewing with an even seam allowance, refer to “Sewing an even seam allowance” on page 40.

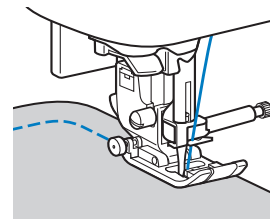

When sewing along a curve while using a zigzag stitch, select a shorter stitch length in order to obtain a finer stitch.

■ Sewing cylindrical pieces

Removing the flat bed attachment allows for free-arm sewing, making it easier to sew cylindrical pieces such as sleeve cuffs and pant legs.

- 1 Pull the flat bed attachment off to the left.

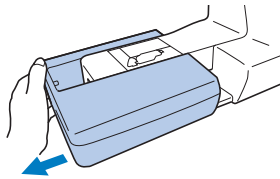

- 2 Slide the part that you wish to sew onto the free arm, and then sew from the top.

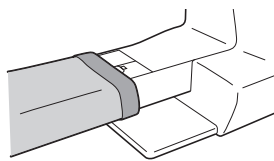

- 3 When you are finished with free arm sewing, install the flat bed attachment back in its original position.

Sewing an even seam allowance

To sew an even seam, start sewing so that the seam allowance is to the right of the presser foot, and the edge of the fabric is aligned with either the right edge of the presser foot or a marking on the needle plate.

■ Changing the needle position

The needle position used as the baseline is different for the straight stitch (left needle position) and the straight stitch (middle (center) needle position).

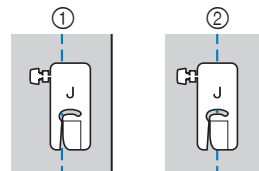

- 1 Straight stitch (left needle position)
- 2 Straight stitch (middle (center) needle position)

When the stitch width of the straight stitch (left needle position) is set to its standard setting (0.0 mm), the distance from the needle position to the right side of the presser foot is 12 mm (1/2 inch). If the stitch width is changed (between 0 and 7.0 mm (1/4 inch)), the needle position will also change. By changing the stitch width and sewing with the right side of the presser foot aligned with the edge of the fabric, a seam allowance can be sewn with a fixed width.

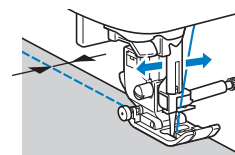
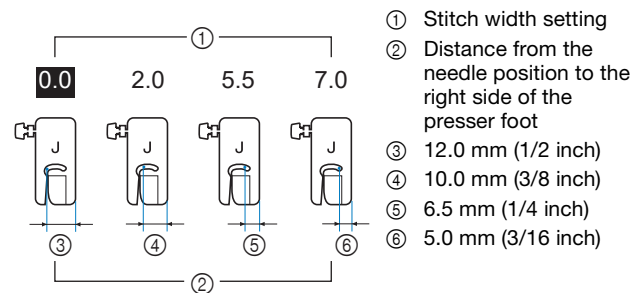

- For details, refer to “Setting the stitch width” on page 38.

■ Aligning the fabric with the stitch guide foot (sold separately with some models)

Sew while keeping the right edge of the fabric aligned with a desired position of markings on the stitch guide foot.

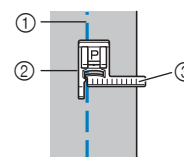

- 1 Seam
- 2 Stitch guide foot
- 3 Markings

■ Aligning the fabric with a needle plate marking

The markings on the needle plate show the distance from the needle position of a seam sewn with the straight stitch (left needle position). Sew while keeping the edge of the fabric aligned with a marking on the needle plate. The distance between the markings in the upper scale is 1/8 inch (3 mm) and the distance between the markings in the grid is 5 mm (3/16 inch).

**For stitches with a left needle position
(Stitch width: 0.0 mm)**

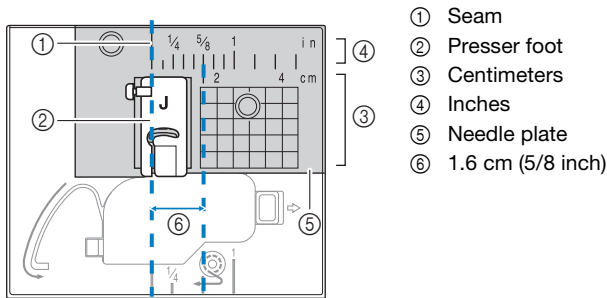

■ Aligning the fabric with zigzag foot “J”

The marking on zigzag foot “J” can be used to sew about 5 mm (3/16 inch) from the edge of the fabric. When using this feature, select a straight stitch, and set the stitch width to 2.0 mm.

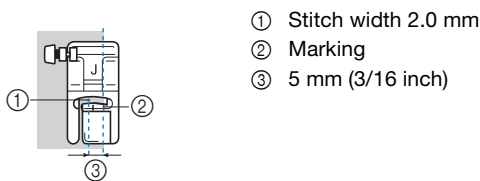

Sewing various fabric

■ Sewing thick fabrics

□ If the fabric does not fit under the presser foot

The presser foot lever can be raised to two different positions. If the fabric does not fit under the presser foot, for example, when sewing together thick fabrics, raise the presser foot lever to its highest position so that the fabric can be placed under the presser foot.

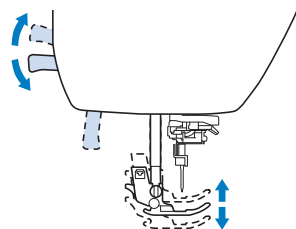

□ If the fabric does not feed

When sewing thick fabric such as denim or quilting, the fabric may not feed at the start of sewing if the presser foot is not level, as shown below. In this case, use the presser foot locking pin (black button on the left side) of zigzag foot “J” so that the presser foot remains level while sewing, allowing the fabric to be fed smoothly.

If the presser foot misalignment is too large, place thick paper or fabric (with the same thickness as the fabric being sewn) under the heel of the presser foot to be able to start sewing smoothly.

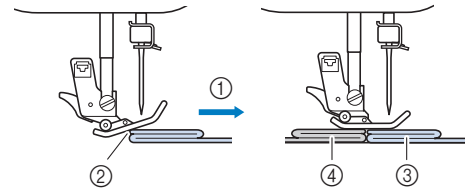

- ① Sewing direction
- ② Misalignment
- ③ Fabric being sewn
- ④ Fabric or thick paper

1 Raise the presser foot lever.

2 Align the beginning of stitching, and then position the fabric.

3 While holding zigzag foot “J” level, push in and hold the presser foot locking pin (black button on the left side), and lower the presser foot lever.

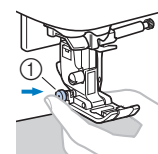

- ① Presser foot locking pin (black button)

4 Release the presser foot locking pin (black button).

→ The presser foot remains level, allowing the fabric to be fed.

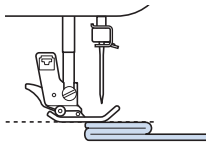

→ After the seam is sewn, the presser foot will return to its original angle.

Memo

- You may find adjusting the [Presser Foot Pressure] in the settings screen helpful on some thick fabrics.
- When [Automatic Fabric Sensor System] in the settings screen is set to [ON], the thickness of the fabric is automatically detected by the internal sensor so the fabric can be fed smoothly for best sewing results. (page 36)

CAUTION

- If fabric more than 6 mm (15/64 inch) thick is sewn or if the fabric is pushed with too much force, the needle may bend or break.

■ Sewing thin fabrics

When sewing thin fabrics such as chiffon, the stitching may become misaligned or the fabric may not feed correctly. Move the needle (be sure to use a fine needle) to the furthest left or right hand position so that the fabric does not get pulled down into the feed dog area. If this occurs or there is shrinkage of the stitching, place non-woven water-soluble stabilizer under the fabric and sew them together.

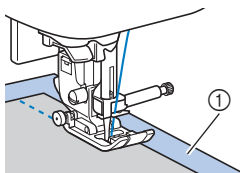

① Water-soluble stabilizer (non-woven)

■ Sewing stretch fabrics

First, baste the pieces of fabric together, and then sew without stretching the fabric. If the stitching is misaligned, place non-woven water-soluble stabilizer under the fabric and sew them together.

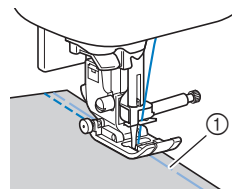

① Basting

For best results when sewing on knit fabrics use the stretch stitches. Also be sure to use a needle for knits (Ball point needle (gold colored)). The recommended stitches and their stitch numbers are indicated below.

No.	1-05	1-06	1-13	1-14	2-13
Stitch					

■ Sewing leathers or vinyl fabrics

When sewing fabrics that may stick to the presser foot, such as leather or vinyl fabrics, replace the presser foot with the walking foot* or non stick foot*.

* Items sold separately with some models, please contact your authorized Brother dealer.

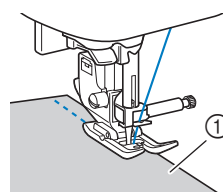

① Leather

If the leather or vinyl fabric sticks to the flat bed attachment, sew with copy paper or tracing paper placed on top of the flat bed attachment so the fabric moves smoothly.

If the paper is positioned so that it does not cover the needle plate, the paper will not be sewn together with the fabric.

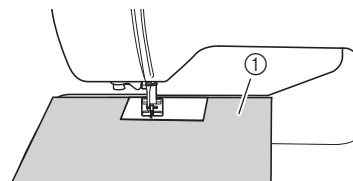

① Copy paper or tracing paper

Note

- When sewing with the walking foot, sew at a speed between slow and medium.
- When using the walking foot, test sew on a scrap piece of leather or vinyl that is to be used in project to make sure foot does not leave any marks.

■ Sewing hook-and-loop fastener tape

⚠ CAUTION

- Use only the adhesive-free hook-and-loop fastener tape which is designed for sewing. When the glue adheres to the needle or the bobbin case, it may cause malfunction.
- If the hook-and-loop fastener tape is sewn with the thin needle (65/9-75/11), the needle may bend or break.

💡 Note

- Before sewing, baste together the fabric and the hook-and-loop fastener tape.

Make sure that the needle passes through the hook-and-loop fastener tape by turning the handwheel and lower the needle into the hook-and-loop fastener tape before sewing. And then, sew the edge of the hook-and-loop fastener tape at a slow speed.

If the needle does not pass through the hook-and-loop fastener tape, replace the needle with the needle size for thicker fabrics. For details, refer to "Fabric/Thread/Needle Combinations" on page 27.

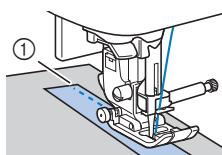

① Edge of the hook-and-loop fastener tape

Hands-free raising and lifting of the presser foot

Using the knee lifter, you can raise and lower the presser foot with your knee, leaving both hands free to handle the fabric.



■ Installing the knee lifter

- 1 Turn off the machine.
- 2 Insert the knee lifter into the mounting slot on the front of the machine in the lower-right corner.

Align the tabs on the knee lifter with the notches in the mounting slot, and then insert the knee lifter as far as possible.

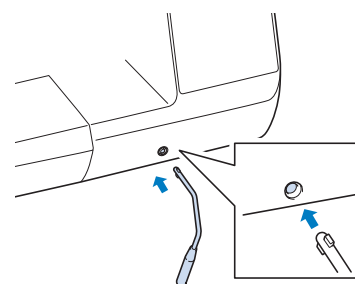

💡 Note

- If the knee lifter is not fully inserted into the mounting slot, it may fall out while the machine is operating.

■ Using the knee lifter

- 1 Stop the machine.
 - Do not use the knee lifter while the machine is operating.
- 2 With your knee, press the knee lifter to the right.
 - Keep the knee lifter pressed to the right.

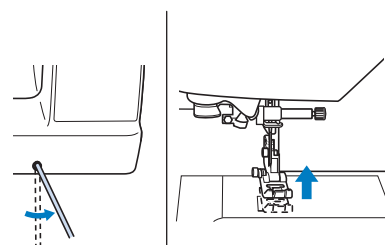

→ The presser foot is raised.

3 Release the knee lifter.

→ The presser foot is lowered.

⚠ CAUTION

- While sewing, keep your knee away from the knee lifter. If the knee lifter is pressed while the machine is operating, the needle may break or the machine may be damaged.

Chapter 3 VARIOUS STITCHES

Stitch Chart

Utility stitches

Applications, stitch lengths and widths and whether the twin needle can be used, are listed for utility stitches in the following table.

Memo

- When any of the following stitches (reverse stitch patterns and reinforcement stitch patterns) are selected, pressing (f) (Reverse stitch button) will sew reverse stitches.

No.	1-01	1-02	1-03	1-04
Stitch				
No.	1-09	1-10	1-11	1-12
Stitch				
No.	1-13	1-14	1-29	1-30
Stitch				
No.	1-31	1-33		
Stitch				

When any other stitch is selected, pressing (f) (Reverse stitch button) will sew reinforcement stitches.

- The stitch pattern symbols indicate the following.

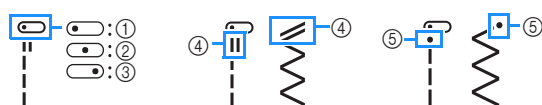















- Left needle position
- Middle (center) needle position
- Right needle position
- Reverse stitch pattern
- Reinforcement stitch pattern













*1 For free motion quilting, use free motion open toe quilting foot "O".

















*2 For free motion quilting, use free motion quilting foot "C" (sold separately with some models) or free motion open toe quilting foot "O".



















*3 Twin needle can be used by attaching zigzag foot "J".

Stitch (Presser foot)	No.	Stitch name/ Applications	Stitch width (mm (inch))	
			Auto.	Manual
	1-01	Straight stitch (Left) *3 General sewing, gather, pintuck, etc.	0.0 (0) 0.0 - 7.0 (0 - 1/4)	2.5 (3/32) 0.2 - 5.0 (1/64 - 3/16)
	1-02	Straight stitch (Left) *3 General sewing, gather, pintuck, etc.	0.0 (0) 0.0 - 7.0 (0 - 1/4)	2.5 (3/32) 0.2 - 5.0 (1/64 - 3/16)
	1-03	Straight stitch (Middle) *3 General sewing, gather, pintuck, etc.	3.5 (1/8) 0.0 - 7.0 (0 - 1/4)	2.5 (3/32) 0.2 - 5.0 (1/64 - 3/16)
	1-04	Straight stitch (Middle) *3 General sewing, gather, pintuck, etc.	3.5 (1/8) 0.0 - 7.0 (0 - 1/4)	2.5 (3/32) 0.2 - 5.0 (1/64 - 3/16)
	1-05	Triple stretch stitch *3 General sewing for reinforcement and decorative topstitching	0.0 (0) 0.0 - 7.0 (0 - 1/4)	2.5 (3/32) 0.4 - 5.0 (1/64 - 3/16)
	1-06	Stem stitch *3 Reinforced stitching, sewing and decorative applications	1.0 (1/16) 0.0 - 7.0 (0 - 1/4)	2.5 (3/32) 0.4 - 5.0 (1/64 - 3/16)
	1-07	Decorative stitch *3 Decorative stitching, top stitching	0.0 (0) 0.0 - 7.0 (0 - 1/4)	2.5 (3/32) 0.4 - 5.0 (1/64 - 3/16)
	1-08	Basting stitch For basting. If the basting threads fall out of the fabric, pull up the bobbin thread before sewing, and then pull the upper thread and bobbin thread under the presser foot toward the back of the machine (page 26). Hold the upper thread and bobbin thread when beginning to sew, and when finished sewing, cut the threads leaving an excess amount of thread. Finally, hold the upper thread and bobbin thread at the beginning of the stitching while arranging the fabric.	0.0 (0) 0.0 - 7.0 (0 - 1/4)	20 (3/4) 5 - 30 (3/16 - 1-3/16)

Stitch (Presser foot)	No.	Stitch name/ Applications	Stitch width (mm (inch))	
			Auto. Manual	Auto. Manual
	1-09	Zigzag stitch *3 For overcasting, mending.	3.5 (1/8) 0.0 - 7.0 (0 - 1/4)	1.4 (1/16) 0.0 - 5.0 (0 - 3/16)
	1-10	Zigzag stitch *3 For overcasting, mending.	3.5 (1/8) 0.0 - 7.0 (0 - 1/4)	1.4 (1/16) 0.0 - 5.0 (0 - 3/16)
	1-11	Zigzag stitch (Right) *3 Start from right needle position, zigzag sew at left.	3.5 (1/8) 2.5 - 5.0 (3/32 - 3/16)	1.4 (1/16) 0.3 - 5.0 (1/64 - 3/16)
	1-12	Zigzag stitch (Left) *3 Start from left needle position, zigzag sew at right.	3.5 (1/8) 2.5 - 5.0 (3/32 - 3/16)	1.4 (1/16) 0.3 - 5.0 (1/64 - 3/16)
	1-13	2 steps elastic zigzag stitch *3 Overcasting (medium weight and stretch fabrics), tape and elastic	5.0 (3/16) 0.0 - 7.0 (0 - 1/4)	1.0 (1/16) 0.2 - 5.0 (1/64 - 3/16)
	1-14	3 steps elastic zigzag stitch *3 Overcasting (medium, heavyweight and stretch fabrics), tape and elastic	5.0 (3/16) 0.0 - 7.0 (0 - 1/4)	1.0 (1/16) 0.2 - 5.0 (1/64 - 3/16)
	1-15	Overcasting stitch Reinforcing of light and medium weight fabrics	3.5 (1/8) 2.5 - 5.0 (3/32 - 3/16)	2.0 (1/16) 0.4 - 5.0 (1/64 - 3/16)
	1-16	Overcasting stitch Reinforcing of heavyweight fabric	5.0 (3/16) 2.5 - 5.0 (3/32 - 3/16)	2.5 (3/32) 0.4 - 5.0 (1/64 - 3/16)
	1-17	Overcasting stitch Reinforcing of medium, heavyweight and easily friable fabrics or decorative stitching.	5.0 (3/16) 3.5 - 5.0 (1/8 - 3/16)	2.5 (3/32) 0.4 - 5.0 (1/64 - 3/16)
	1-18	Overcasting stitch *3 Reinforced seaming of stretch fabric	5.0 (3/16) 0.0 - 7.0 (0 - 1/4)	2.5 (3/32) 0.4 - 5.0 (1/64 - 3/16)
	1-19	Overcasting stitch *3 Reinforcing of medium stretch fabric and heavyweight fabric, decorative stitching	5.0 (3/16) 0.0 - 7.0 (0 - 1/4)	2.5 (3/32) 0.4 - 5.0 (1/64 - 3/16)
	1-20	Overcasting stitch *3 Reinforcement of stretch fabric or decorative stitching	4.0 (3/16) 0.0 - 7.0 (0 - 1/4)	4.0 (3/16) 0.4 - 5.0 (1/64 - 3/16)
	1-21	Overcasting stitch Stretch knit seam	5.0 (3/16) 0.0 - 7.0 (0 - 1/4)	4.0 (3/16) 0.4 - 5.0 (1/64 - 3/16)
	1-22	Single diamond overcast stitch *3 Reinforcement and seaming stretch fabric	6.0 (15/64) 0.0 - 7.0 (0 - 1/4)	3.0 (1/8) 0.4 - 5.0 (1/64 - 3/16)

















Stitch (Presser foot)	No.	Stitch name/ Applications	Stitch width (mm (inch))	
			Auto. Manual	Auto. Manual
	1-23	Single diamond overcast stitch *3 Reinforcement of stretch fabric	6.0 (15/64) 0.0 - 7.0 (0 - 1/4)	1.8 (1/16) 0.4 - 5.0 (1/64 - 3/16)
	1-24	With side cutter Straight stitch while cutting fabrics	0.0 (0) 0.0 - 2.5 (0 - 3/32)	2.5 (3/32) 0.2 - 5.0 (1/64 - 3/16)
	1-25	With side cutter Zigzag stitch while cutting fabrics	3.5 (1/8) 3.5 - 5.0 (1/8 - 3/16)	1.4 (1/16) 0.0 - 5.0 (0 - 3/16)
	1-26	With side cutter Overcasting stitch while cutting fabrics	3.5 (1/8) 3.5 - 5.0 (1/8 - 3/16)	2.0 (1/16) 0.4 - 5.0 (1/64 - 3/16)
	1-27	With side cutter Overcasting stitch while cutting fabrics	5.0 (3/16) 3.5 - 5.0 (1/8 - 3/16)	2.5 (3/32) 0.4 - 5.0 (1/64 - 3/16)
	1-28	With side cutter Overcasting stitch while cutting fabrics	5.0 (3/16) 3.5 - 5.0 (1/8 - 3/16)	2.5 (3/32) 0.4 - 5.0 (1/64 - 3/16)
	1-29	Piecing stitch (Right) Piecework/patchwork 6.5 mm (approx. 1/4 inch) right seam allowance	5.5 (7/32) 0.0 - 7.0 (0 - 1/4)	2.0 (1/16) 0.2 - 5.0 (1/64 - 3/16)
	1-30	Piecing stitch (Middle) Piecework/patchwork	—	2.0 (1/16) 0.2 - 5.0 (1/64 - 3/16)
	1-31	Piecing stitch (Left) Piecework/patchwork 6.5 mm (approx. 1/4 inch) left seam allowance	1.5 (1/16) 0.0 - 7.0 (0 - 1/4)	2.0 (1/16) 0.2 - 5.0 (1/64 - 3/16)
	1-32	Hand-look quilting stitch Quilting stitch made to look like hand quilting when using transparent nylon thread for the upper thread and a thread color matching the quilt for the bobbin thread. Sew with a tight thread tension so that the bobbin thread is visible from the right side of the fabric. Use a needle between 90/14 and 100/16.	0.0 (0) 0.0 - 7.0 (0 - 1/4)	2.5 (3/32) 0.4 - 5.0 (1/64 - 3/16)
	1-33	Quilting appliqué zigzag stitch Zigzag stitch for quilting and sewing on appliqué quilt pieces	3.5 (1/8) 0.0 - 7.0 (0 - 1/4)	1.4 (1/16) 0.0 - 5.0 (0 - 3/16)
	1-34	Quilting appliqué stitch Quilting stitch for invisible appliqué or attaching binding	1.5 (1/16) 0.0 - 7.0 (0 - 1/4)	1.8 (1/16) 0.4 - 5.0 (1/64 - 3/16)













Stitch (Presser foot)	No.	Stitch name/ Applications	Stitch	
			width (mm (inch)) Auto. Manual	length (mm (inch)) Auto. Manual
 (C*1)	1-35	Quilting stippling stitch Background quilting	7.0 (1/4) 0.0 - 7.0 (0 - 1/4)	1.6 (1/16) 0.4 - 5.0 (1/64 - 3/16)
 (E)	2-01	Blind hem stitch Hemming woven fabrics * The stitch width setting is in neither millimeters nor inches.	00 3← - →3	2.0 (1/16) 0.4 - 5.0 (1/64 - 3/16)
 (E)	2-02	Blind hem stretch stitch Hemming stretch fabric * The stitch width setting is in neither millimeters nor inches.	00 3← - →3	2.0 (1/16) 0.4 - 5.0 (1/64 - 3/16)
 (C)	2-03	Blanket stitch ^{*3} Appliqués, decorative blanket stitch	3.5 (1/8) 0.0 - 7.0 (0 - 1/4)	2.5 (3/32) 0.4 - 5.0 (1/64 - 3/16)
 (C*1)	2-04	Shell tuck edge stitch ^{*3} Shell tuck edge finish on fabrics	4.0 (3/16) 0.0 - 7.0 (0 - 1/4)	2.5 (3/32) 0.2 - 5.0 (1/64 - 3/16)
 (Z*1)	2-05	Satin scallop stitch ^{*3} Decorating collar of blouse, edge of handkerchief	5.0 (3/16) 0.0 - 7.0 (0 - 1/4)	0.5 (1/32) 0.1 - 5.0 (1/64 - 3/16)
 (Z*1)	2-06	Scallop stitch Decorating collar of blouse, edge of handkerchief	7.0 (1/4) 0.0 - 7.0 (0 - 1/4)	1.4 (1/16) 0.4 - 5.0 (1/64 - 3/16)
 (C*1)	2-07	Patchwork join stitch ^{*3} Patchwork stitches, decorative stitching	4.0 (3/16) 0.0 - 7.0 (0 - 1/4)	1.2 (1/16) 0.2 - 5.0 (1/64 - 3/16)
 (C*1)	2-08	Patchwork double overlock stitch ^{*3} Patchwork stitches, decorative stitching	5.0 (3/16) 0.0 - 7.0 (0 - 1/4)	2.5 (3/32) 0.4 - 5.0 (1/64 - 3/16)
 (C*1)	2-09	Couching stitch ^{*3} Decorative stitching, attaching cord and couching	5.0 (3/16) 0.0 - 7.0 (0 - 1/4)	1.2 (1/16) 0.2 - 5.0 (1/64 - 3/16)
 (C*1)	2-10	Smocking stitch ^{*3} Smocking, decorative stitching	5.0 (3/16) 0.0 - 7.0 (0 - 1/4)	1.6 (1/16) 0.4 - 5.0 (1/64 - 3/16)
 (C*1)	2-11	Feather stitch ^{*3} Fagoting, decorative stitching	5.0 (3/16) 0.0 - 7.0 (0 - 1/4)	2.5 (3/32) 0.4 - 5.0 (1/64 - 3/16)
 (C*1)	2-12	Fagoting cross stitch ^{*3} Fagoting, bridging and decorative stitching	5.0 (3/16) 0.0 - 7.0 (0 - 1/4)	2.5 (3/32) 0.4 - 5.0 (1/64 - 3/16)
 (C*1)	2-13	Tape attaching stitch ^{*3} Attaching tape to seam in stretch fabric	4.0 (3/16) 0.0 - 7.0 (0 - 1/4)	1.0 (1/16) 0.2 - 5.0 (1/64 - 3/16)
 (Z*1)	2-14	Ladder stitch Decorative stitching	4.0 (3/16) 0.0 - 7.0 (0 - 1/4)	3.0 (1/8) 0.4 - 5.0 (1/64 - 3/16)
 (C*1)	2-15	Rick-rack stitch ^{*3} Decorative top stitching	4.0 (3/16) 0.0 - 7.0 (0 - 1/4)	2.5 (3/32) 0.4 - 5.0 (1/64 - 3/16)

Stitch (Presser foot)	No.	Stitch name/ Applications	Stitch	
			width (mm (inch)) Auto. Manual	length (mm (inch)) Auto. Manual
 (C*1)	2-16	Decorative stitch ^{*3} Decorative stitching	5.5 (7/32) 0.0 - 7.0 (0 - 1/4)	1.6 (1/16) 0.4 - 5.0 (1/64 - 3/16)
 (N*1)	2-17	Serpentine stitch ^{*3} Decorative stitching and attaching elastic	5.0 (3/16) 0.0 - 7.0 (0 - 1/4)	1.0 (1/16) 0.2 - 5.0 (1/64 - 3/16)
 (N*1)	2-18	Decorative stitch ^{*3} Decorative stitching and appliqué	6.0 (15/64) 0.0 - 7.0 (0 - 1/4)	1.0 (1/16) 0.2 - 5.0 (1/64 - 3/16)
 (N*1)	2-19	Decorative stippling stitch Decorative stitching	7.0 (1/4) 0.0 - 7.0 (0 - 1/4)	1.6 (1/16) 0.4 - 5.0 (1/64 - 3/16)
 (C*1)	2-20	Blanket stitch ^{*3} Appliqués, decorative blanket stitch	2.5 (3/32) 0.0 - 7.0 (0 - 1/4)	2.5 (3/32) 0.4 - 5.0 (1/64 - 3/16)
 (N*1)	3-01	Hemstitching ^{*3} Decorative hems, triple straight at left	1.0 (1/16) 0.0 - 7.0 (0 - 1/4)	2.5 (3/32) 0.4 - 5.0 (1/64 - 3/16)
 (N*1)	3-02	Hemstitching ^{*3} Decorative hems, triple straight at center	3.5 (1/8) 0.0 - 7.0 (0 - 1/4)	2.5 (3/32) 0.4 - 5.0 (1/64 - 3/16)
 (N*1)	3-03	Hemstitching zigzag ^{*3} Decorative hems, top stitching	6.0 (15/64) 0.0 - 7.0 (0 - 1/4)	3.0 (1/8) 0.4 - 5.0 (1/64 - 3/16)
 (N*1)	3-04	Hemstitching Decorative hems, lace attaching pin stitch	3.5 (1/8) 0.0 - 7.0 (0 - 1/4)	2.5 (3/32) 0.4 - 5.0 (1/64 - 3/16)
 (N*1)	3-05	Hemstitching Decorative hems	3.0 (1/8) 0.0 - 7.0 (0 - 1/4)	3.5 (1/8) 0.4 - 5.0 (1/64 - 3/16)
 (N*1)	3-06	Hemstitching Decorative hems, daisy stitch	6.0 (15/64) 0.0 - 7.0 (0 - 1/4)	3.0 (1/8) 0.4 - 5.0 (1/64 - 3/16)
 (N*1)	3-07	Hemstitching Heirloom, decorative hems	5.0 (3/16) 0.0 - 7.0 (0 - 1/4)	3.5 (1/8) 0.4 - 5.0 (1/64 - 3/16)
 (N*1)	3-08	Hemstitching Heirloom, decorative hems	5.0 (3/16) 0.0 - 7.0 (0 - 1/4)	3.5 (1/8) 0.4 - 5.0 (1/64 - 3/16)
 (N*1)	3-09	Hemstitching ^{*3} Heirloom, decorative hems	5.0 (3/16) 0.0 - 7.0 (0 - 1/4)	3.5 (1/8) 0.4 - 5.0 (1/64 - 3/16)
 (N*1)	3-10	Hemstitching ^{*3} Heirloom, decorative hems	5.0 (3/16) 0.0 - 7.0 (0 - 1/4)	4.0 (3/16) 0.4 - 5.0 (1/64 - 3/16)
 (N*1)	3-11	Hemstitching ^{*3} Heirloom, decorative hems	4.0 (3/16) 0.0 - 7.0 (0 - 1/4)	2.5 (3/32) 0.4 - 5.0 (1/64 - 3/16)
 (N*1)	3-12	Honeycomb stitch ^{*3} Heirloom, decorative hems	5.0 (3/16) 0.0 - 7.0 (0 - 1/4)	2.5 (3/32) 0.4 - 5.0 (1/64 - 3/16)
 (N*1)	3-13	Honeycomb stitch ^{*3} Heirloom, decorative hems	6.0 (15/64) 0.0 - 7.0 (0 - 1/4)	3.5 (1/8) 0.4 - 5.0 (1/64 - 3/16)

3

VARIOUS STITCHES

Stitch (Presser foot)	No.	Stitch name/ Applications	Stitch	
			width (mm (inch)) Auto. Manual	length (mm (inch)) Auto. Manual
	3-14	Hemstitch ^{*3} Heirloom, decorative hems	6.0 (15/64) 0.0 - 7.0 (0 - 1/4)	1.6 (1/16) 0.4 - 5.0 (1/64 - 3/16)
	3-15	Hemstitch Heirloom, decorative hems	6.0 (15/64) 0.0 - 7.0 (0 - 1/4)	3.0 (1/8) 0.4 - 5.0 (1/64 - 3/16)
	3-16	Hemstitch ^{*3} Heirloom, decorative hems	6.0 (15/64) 0.0 - 7.0 (0 - 1/4)	4.0 (3/16) 0.4 - 5.0 (1/64 - 3/16)
	3-17	Hemstitch Heirloom, decorative hems	4.0 (3/16) 0.0 - 7.0 (0 - 1/4)	2.5 (3/32) 0.4 - 5.0 (1/64 - 3/16)
	3-18	Hemstitch ^{*3} Heirloom, decorative hems	5.0 (3/16) 0.0 - 7.0 (0 - 1/4)	2.0 (1/16) 0.4 - 5.0 (1/64 - 3/16)
	3-19	Hemstitch ^{*3} Decorative hems and bridging stitch	6.0 (15/64) 0.0 - 7.0 (0 - 1/4)	2.0 (1/16) 0.4 - 5.0 (1/64 - 3/16)
	3-20	Hemstitch ^{*3} Decorative hems. Fagoting, attaching ribbon	5.0 (3/16) 0.0 - 7.0 (0 - 1/4)	3.0 (1/8) 0.4 - 5.0 (1/64 - 3/16)
	3-21	Hemstitch Decorative hems, smocking	6.0 (15/64) 0.0 - 7.0 (0 - 1/4)	1.6 (1/16) 0.4 - 5.0 (1/64 - 3/16)
	3-22	Hemstitch Decorative hems, smocking	5.0 (3/16) 0.0 - 7.0 (0 - 1/4)	1.6 (1/16) 0.4 - 5.0 (1/64 - 3/16)
	4-01	Narrow rounded buttonhole stitch Buttonhole on light to medium weight fabrics	5.0 (3/16) 3.0 - 6.0 (1/8 - 15/64)	0.4 (1/64) 0.2 - 1.0 (1/64 - 1/16)
	4-02	Tapered round ended buttonhole stitch Reinforced waist tapered buttonholes	5.0 (3/16) 3.0 - 6.0 (1/8 - 15/64)	0.4 (1/64) 0.2 - 1.0 (1/64 - 1/16)
	4-03	Round ended buttonhole stitch Buttonholes with vertical bar tack in heavyweight fabrics	5.0 (3/16) 3.0 - 6.0 (1/8 - 15/64)	0.4 (1/64) 0.2 - 1.0 (1/64 - 1/16)
	4-04	Narrow squared buttonhole stitch Buttonholes for light to medium weight fabrics	5.0 (3/16) 3.0 - 6.0 (1/8 - 15/64)	0.4 (1/64) 0.2 - 1.0 (1/64 - 1/16)
	4-05	Stretch buttonhole stitch Buttonholes for stretch or woven fabrics	6.0 (15/64) 3.0 - 6.0 (1/8 - 15/64)	1.0 (1/16) 0.5 - 2.0 (1/32 - 1/16)
	4-06	Heirloom buttonhole stitch Buttonholes for heirloom and stretch fabrics	6.0 (15/64) 3.0 - 6.0 (1/8 - 15/64)	1.5 (1/16) 1.0 - 3.0 (1/16 - 1/8)
	4-07	Bound buttonhole stitch The first step in making bound buttonholes	5.0 (3/16) 0.0 - 6.0 (0 - 15/64)	2.0 (1/16) 0.2 - 4.0 (1/64 - 3/16)

Stitch (Presser foot)	No.	Stitch name/ Applications	Stitch	
			width (mm (inch)) Auto. Manual	length (mm (inch)) Auto. Manual
	4-08	Keyhole buttonhole stitch Buttonholes in heavyweight or thick fabrics for larger flat buttons	7.0 (1/4) 3.0 - 7.0 (1/8 - 1/4)	0.5 (1/32) 0.3 - 1.0 (1/64 - 1/16)
	4-09	Tapered keyhole buttonhole stitch Buttonholes in medium to heavy weight fabrics for larger flat buttons	7.0 (1/4) 3.0 - 7.0 (1/8 - 1/4)	0.5 (1/32) 0.3 - 1.0 (1/64 - 1/16)
	4-10	Keyhole buttonhole stitch Buttonholes with vertical bar tack for reinforcement in heavyweight or thick fabrics	7.0 (1/4) 3.0 - 7.0 (1/8 - 1/4)	0.5 (1/32) 0.3 - 1.0 (1/64 - 1/16)
	4-11	Darning stitch Darning of medium weight fabric	7.0 (1/4) 2.5 - 7.0 (3/32 - 1/4)	2.0 (1/16) 0.4 - 2.5 (1/64 - 3/32)
	4-12	Darning stitch Darning of heavyweight fabric	7.0 (1/4) 2.5 - 7.0 (3/32 - 1/4)	2.0 (1/16) 0.4 - 2.5 (1/64 - 3/32)
	4-13	Bar tack stitch Reinforcement at opening of pocket, etc.	2.0 (1/16) 1.0 - 3.0 (1/16 - 1/8)	0.4 (1/64) 0.3 - 1.0 (1/64 - 1/16)
	4-14	Button sewing stitch Attaching buttons	3.5 (1/8) 2.5 - 4.5 (3/32 - 3/16)	—
	4-15	Eyelet stitch For making eyelets, holes on belts, etc.	7.0 (1/4) 7.0 6.0 5.0 (1/4 15/64 3/16)	7.0 (1/4) 7.0 6.0 5.0 (1/4 15/64 3/16)
	5-01	Reverse (Straight stitch) For attaching appliqué on tubular pieces of fabric and mitering corners	—	—
	5-02	Sideways to left (Straight stitch) For attaching appliqué on tubular pieces of fabric	—	—
	5-03	Sideways to right (Straight stitch) For attaching appliqué on tubular pieces of fabric	—	—
	5-04	Forward (Straight stitch) For attaching appliqué on tubular pieces of fabric and mitering corners	—	—
	5-05	Sideways to left (Zigzag stitch) For attaching appliqué on tubular pieces of fabric	—	—

Stitch (Presser foot)	No.	Stitch name/ Applications	Stitch width (mm (inch)) Auto. Manual	Stitch length (mm (inch)) Auto. Manual
	5-06	Sideways to right (Zigzag stitch) For attaching appliqué on tubular pieces of fabric	—	—
	5-07	Forward (Zigzag stitch) For attaching appliqué on tubular pieces of fabric and mitering corners	—	—
	5-08	Reverse (Zigzag stitch) For attaching appliqué on tubular pieces of fabric and mitering corners	—	—

Decorative stitches

Use monogramming foot "N".

The twin needle can only be used with satin stitch

Be sure to attach zigzag foot "J" when using the twin needle.

Decorative stitches						
6-01	6-02	6-03	6-04	6-05	6-06	6-07
6-08	6-09	6-10	6-11	6-12	6-13	6-14
6-15	6-16	6-17	6-18	6-19	6-20	6-21
6-22	6-23	6-24	6-25	6-26	6-27	6-28
6-29	6-30	6-31	6-32	6-33	6-34	6-35
6-36	6-37	6-38	6-39	6-40	6-41	6-42
6-43	6-44	6-45	6-46	6-47	6-48	6-49
6-50	6-51	6-52	6-53	6-54	6-55	6-56
6-57	6-58	6-59	6-60	6-61	6-62	6-63
6-64	6-65	6-66	6-67	6-68	6-69	6-70
6-71	6-72	6-73	6-74	6-75	6-76	6-77
6-78	6-79	6-80	6-81	6-82	6-83	6-84

3

VARIOUS STITCHES

Satin stitches						
7-01	7-02	7-03	7-04	7-05	7-06	7-07
7-08	7-09	7-10	7-11	7-12	7-13	7-14
7-15	7-16	7-17	7-18			
7 mm satin stitches						
8-01	8-02	8-03	8-04	8-05	8-06	8-07
8-08	8-09	8-10	8-11	8-12	8-13	8-14
8-15	8-16	8-17				
Cross stitch stitches						
9-01	9-02	9-03	9-04	9-05	9-06	9-07
9-08	9-09	9-10	9-11	9-12	9-13	9-14
Utility decorative stitches						
10-01	10-02	10-03	10-04	10-05	10-06	10-07
10-08	10-09	10-10	10-11	10-12	10-13	10-14
10-15	10-16	10-17	10-18	10-19	10-20	10-21
10-22	10-23	10-24	10-25	10-26	10-27	10-28
10-29	10-30	10-31	10-32	10-33	10-34	10-35
10-36	10-37	10-38	10-39	10-40	10-41	10-42
10-43	10-44	10-45	10-46	10-47	10-48	10-49
10-50	10-51	10-52	10-53	10-54	10-55	10-56
10-57	10-58					

■ Character stitches

Use monogramming foot "N".
The twin needle cannot be used.

Character stitches (Gothic font)																																																																																																																																																														
A	B	C	D	E	F	G	H	I	J	K	L	M	N	O	P	Q	R	S	T	U	V	W	X	Y	Z	a	b	c	d	e	f	g	h	i	j	k	l	m	n	o	p	q	r	s	t	u	v	w	x	y	z	_	0	1	2	3	4	5	6	7	8	9	#	%	\$	£	€	¥	-	+	X	÷	=	*	.	,	&	?	!	@	<	>	()	[]	/	\	~	:	;	©	®	™	“	”	”	’	‘	’	_	Â	Ä	Å	Æ	à	á	â	ã	ä	å	æ	Ç	ç	Ð	È	É	Ê	Ë	è	é	ê	ë	Í	Ï	Ì	ì	í	ï	ı	Ñ	ñ	ñ	Ô	Ö	Ø	Õ	Œ	ò	ó	ô	ö	ø	ø	æ	ŗ	ţ	Û	Û	ù	ú	û	ü	ž	ƀ	Ɓ	Ƃ	_
Character stitches (Handwriting font)																																																																																																																																																														
A	B	C	D	E	F	G	H	I	J	K	L	M	N	O	P	Q	R	S	T	U	V	W	X	Y	Z	a	b	c	d	e	f	g	h	i	j	k	l	m	n	o	p	q	r	s	t	u	v	w	x	y	z	_	0	1	2	3	4	5	6	7	8	9	#	%	\$	£	€	¥	-	+	X	÷	=	*	.	,	&	?	!	@	<	>	()	[]	/	\	~	:	;	©	®	™	“	”	”	’	‘	’	_	À	Ä	Å	Æ	à	á	â	ã	ä	å	æ	Ç	ç	Ð	È	É	Ê	Ë	è	é	ê	ë	Í	Ï	Ì	ì	í	ï	ı	Ñ	ñ	ñ	Ô	Ö	Ø	Õ	Œ	ò	ó	ô	ö	ø	ø	æ	ŗ	ţ	Û	Û	ù	ú	û	ü	ž	ƀ	Ɓ	Ƃ	_

Character stitches (Outline)

A B C D E F G H I J K L
M N O P Q R S T U V W X
Y Z a b c d e f g h i j
k l m n o p q r s t u v
w x y z _
0 1 2 3 4 5 6 7 8 9 # %
\$ & € ¥ ¤ + × ÷ ≡ * ° ,
& ? ! @ < > () [] / \
~ : ; © ® ™ “ ” ” ’ ° ’
—
Â Ä Å Æ à á â ã ä å æ Ç
Ç Ð Ë Ì Í Î Ï è é ê ë í î
ï ï ï ï ï ï Ñ Ñ ñ Ò Ö Ø Õ
Œ ò ó ô ö ø õ œ ř ť Ů ů
ù ú û ü ź P P B _

Character stitches (Cyrillic font)

А В В Г Д Е Ё Ж З И Й К
Л М Н О П Р С Т У Ф Х Ц
Ч Ш Щ Ъ Ы Ь Э Ю Я Г Е І
Ї Ў Һ Һ Ј Љ Њ Ц Ѓ С К _
а б в г д е ё ж з и й к
л м н о п р с т у ф х ц
ч ш щ ъ ы ь э ю я г е і
ї ў һ һ ј љ њ ц ѓ с к _
0 1 2 3 4 5 6 7 8 9 — .
, & ? ! () / ’ _

Character stitches (Japanese font)

あいうえおあいうえお
かきくけこがぎぐげご
さしすせそざじずぜぞ
たちつてとだぢづでどっ
なにぬねのはひふへほ
ばびぶべぼぱぴぷぺぽ
まみむめもやゆよやゆよ
らりるれろわをん _
アイウエオアイウエオヴ
カキクケコガギグゲゴ
サシスセソザジズゼゾ
タチツテトダヂツデドッ
ナニヌネノハヒフヘホ
バビブベボパピプペポ
マミムメモヤユヨヤユヨ
ラリルレロワヲン _
0 1 2 3 4 5 6 7 8 9
〇 一 二 三 四 五 六 七 八 九 十
& ? ! () — _
生年月日才保育幼稚園小中
学校組部火水木金土 _

Utility Stitches

⚠ CAUTION

- Before replacing the presser foot, be sure that you have pressed  (Presser foot/Needle exchange key) on the operation panel to lock all keys and buttons, otherwise injuries may occur if the “Start/Stop” button or any other button is pressed and the machine starts. For details on changing the presser foot, refer to “Replacing the Presser Foot” on page 29.

Overcasting stitches

Sew overcasting stitches along the edges of cut fabric to prevent them from fraying.

■ Using overcasting foot “G”

- 1 Attach overcasting foot “G”.



- 2 Select a stitch.

No.	1-15	1-16	1-17
Stitch			

- For details, refer to “Stitch Chart” on page 45.

⚠ CAUTION

- When using overcasting foot “G”, be sure select a stitch that can be used with overcasting foot “G”. If you sew with the incorrect stitch, the needle may hit the presser foot, bending the needle or damaging the presser foot.

- 3 Position the fabric with the edge of the fabric against the guide of the presser foot, and then lower the presser foot lever.

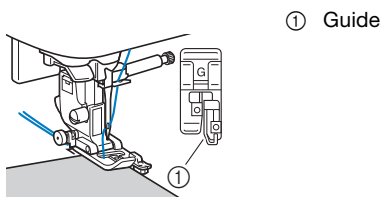

- 4 Rotate the handwheel toward you (counterclockwise). Check that the needle does not touch the presser foot.

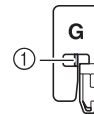

- 5 Sew with the edge of the fabric against the presser foot guide.

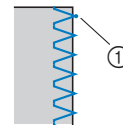

⚠ CAUTION

- Be sure to pull the fabric backward after finished sewing. If you pull the fabric toward side or forward, the presser foot pin may be damaged.
- If thread is tangled on the presser foot, remove the entangled thread, and then raise the presser foot lever to remove the presser foot. If the presser foot is raised while entangled with thread, the presser foot may be damaged.

- 6 Press the “Start/Stop” button to stop sewing when you have reached the end of the stitching, and raise the presser foot and needle to pull the fabric under the presser foot towards the back of the machine.

■ Using zigzag foot “J”

- 1 Attach zigzag foot “J”.

- 2 Select a stitch.

No.	1-09	1-10	1-11	1-12
Stitch				
No.	1-13	1-14	1-18	1-19
Stitch				
No.	1-20	1-21	1-22	1-23
Stitch				

- For details, refer to “Stitch Chart” on page 45.

- 3 Sew along the edge of the fabric with the needle dropping off the edge at the right.

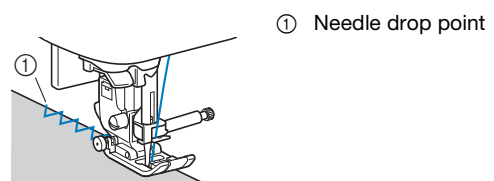

■ Sewing overcasting stitches using the side cutter (sold separately with some models)

Using the side cutter, seam allowances can be finished while the edge of the fabric is cut off. Five utility stitches can be used to sew overcasting stitches with the side cutter.

💡 Note

- Thread the needle manually when using the side cutter, or only attach the side cutter after threading the needle using the needle threader.

□ Side cutter

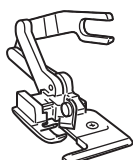

⚠ CAUTION

- When using the side cutter, sew between low and medium speed and do not touch the knives or connecting fork of the side cutter while sewing to avoid equipment damage or injury.

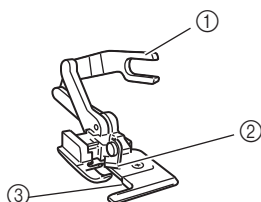

- ① Connecting fork
- ② Upper knife
- ③ Guide plate (lower knife)

1 Remove the presser foot. (page 29)

2 Hook the connecting fork of the side cutter onto the needle clamp screw.

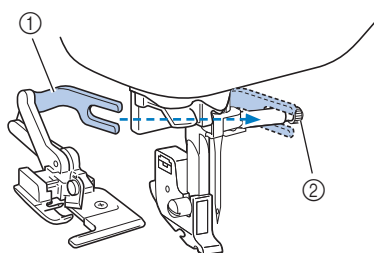

- ① Connecting fork
- ② Needle clamp screw

3 Position the side cutter so that side cutter pin is aligned with the notch in the presser foot holder, and then slowly lower the presser foot lever.

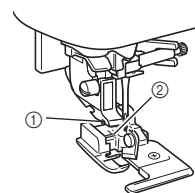

- ① Notch in presser foot holder
- ② Pin

💡 Note

- When it is hard to set under the presser foot holder, fit the pin on the side cutter into the notch of the presser foot holder raising up the presser foot lever higher.

4 Raise the presser foot lever to check that the side cutter is securely attached.

5 Pass the upper thread under the side cutter, and then pull it out toward the rear of the machine.

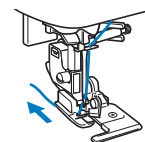

6 Select a stitch.

No.	1-24	1-25	1-26	1-27
Stitch				
No.	1-28			
Stitch				

- For details, refer to “Stitch Chart” on page 45.

7 Make a cut of about 2 cm (3/4 inch) long in the fabric at the beginning of the stitching.

① 2 cm (3/4 inch)

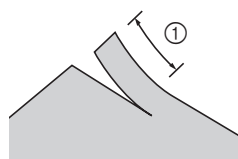

8 Position the fabric in the side cutter.

The cut in the fabric should be positioned over the guide plate of the side cutter.

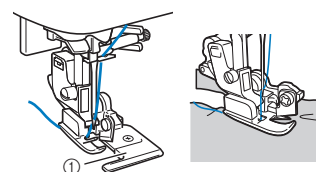

- ① Guide plate

- If the fabric is not positioned correctly, the fabric will not be cut.

9 Lower the presser foot lever, and then start sewing.

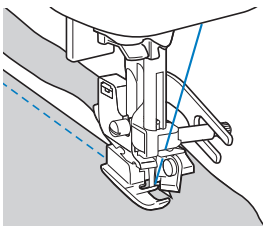

→ A seam allowance is cut while the stitching is sewn.

- If the stitching is sewn in a straight line , the seam allowance will be about 5 mm (3/16 inch).

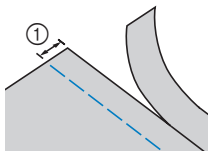

① 5 mm (3/16 inch)

Memo

- The side cutter can cut as much as one layer of 13-oz. denim.
- After using the side cutter, clean it by removing any lint or dust.
- If the side cutter can no longer cut fabric, use a piece of cloth to apply a small amount of oil to the cutting edge of the cutter.

Blind hem stitching

Secure the lower edge of skirts and pants with a blind hem.

Memo

- When the size of cylindrical pieces is too small to slide onto the arm or the length is too short, the fabric will not feed and desired results may not be achieved.

1 Turn the skirt or pants inside out.



- ① Wrong side of fabric
- ② Right side of fabric
- ③ Lower edge of fabric

2 Fold the lower edge of fabric to the desired length to be hemmed and then press.

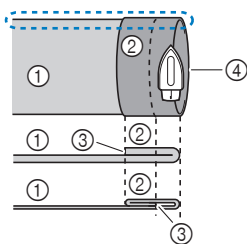

- ① Wrong side of fabric
- ② Right side of fabric
- ③ Lower edge of fabric
- ④ Desired length for hem

<Thick fabric>

<Normal fabric>

<Seen  from the side>

3 Using tailor's chalk, mark the fabric about 5 mm (3/16 inch) from the edge of the fabric, and then baste it.

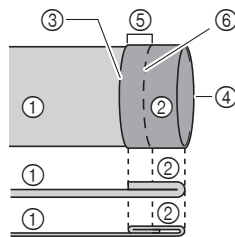

- ① Wrong side of fabric
- ② Right side of fabric
- ③ Lower edge of fabric
- ④ Desired length for hem
- ⑤ 5 mm (3/16 inch)
- ⑥ Basting

<Thick fabric>

<Normal fabric>

<Seen from the side>

4 Fold back the fabric inside along the basting.

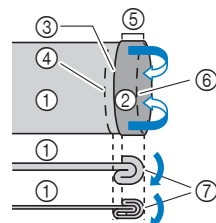

- ① Wrong side of fabric
- ② Right side of fabric
- ③ Lower edge of fabric
- ④ Desired length for hem
- ⑤ 5 mm (3/16 inch)
- ⑥ Basting
- ⑦ Basting point

<Thick fabric>

<Normal fabric>

<Seen from the side>

5 Unfold the edge of fabric, and position the fabric with the wrong side facing up.

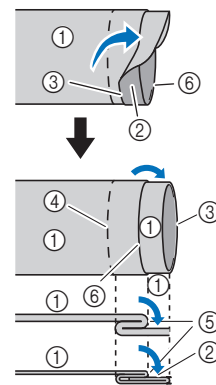

- ① Wrong side of fabric
- ② Right side of fabric
- ③ Edge of fabric
- ④ Desired edge of hem
- ⑤ Basting point
- ⑥ Basting

<Thick fabric>



<Normal fabric>

<Seen from the side>

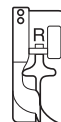
6 Attach blind stitch foot "R".



7 Select a stitch.

No.	2-01	2-02
Stitch		

- For details, refer to "Stitch Chart" on page 45.

8 Remove the flat bed attachment to use the free arm.

9 Slide the item that you wish to sew onto the free arm, make sure that the fabric feeds correctly, and then start sewing.

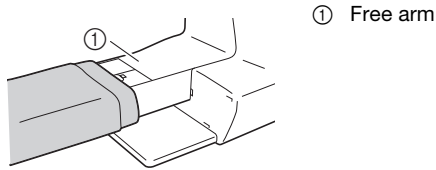

10 Position the fabric with the edge of the folded hem against the guide of the presser foot, and then lower the presser foot lever.

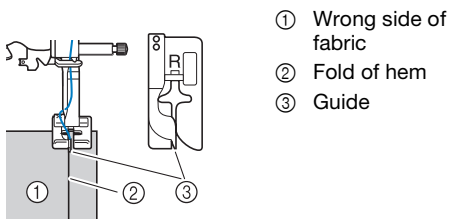

11 Adjust the stitch width until the needle slightly catches the fold of the hem. (page 38)

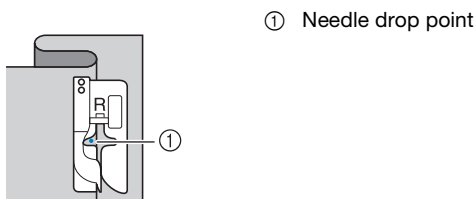

When you change the needle drop point, raise the needle, and then change the stitch width.

* To make fine adjustments to the needle drop point, adjust the stitch width setting. (The stitch width setting is in neither millimeters nor inches.)

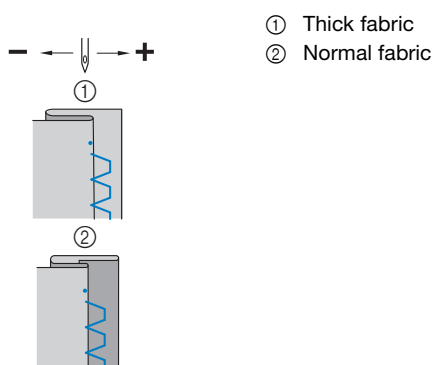

Memo

- Blind hem stitches cannot be sewn if the left needle drop point does not catch the fold. If the needle catches too much of the fold, the fabric cannot be unfolded and the seam appearing on the right side of the fabric will be very large, leaving an unattractive finish.

12 Sew with the fold of the hem against the presser foot guide.

13 Press the “Start/Stop” button to stop sewing when you are finished, and raise the presser foot and needle to pull the fabric under the presser foot towards the back of the machine.

Note

- Be sure to pull the fabric towards the back of the machine after sewing. If you pull the fabric toward side or forward, the presser foot may be damaged.

14 Remove the basting stitching and turn the fabric with the right side facing out.

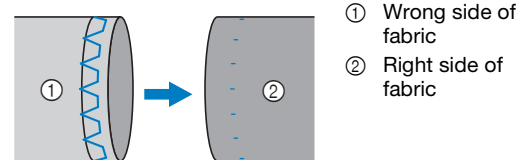

Buttonhole sewing

The maximum buttonhole length is about 28 mm (1-1/8 inches) (diameter + thickness of the button).

Buttonholes are sewn from the front of the presser foot to the back, as shown below.

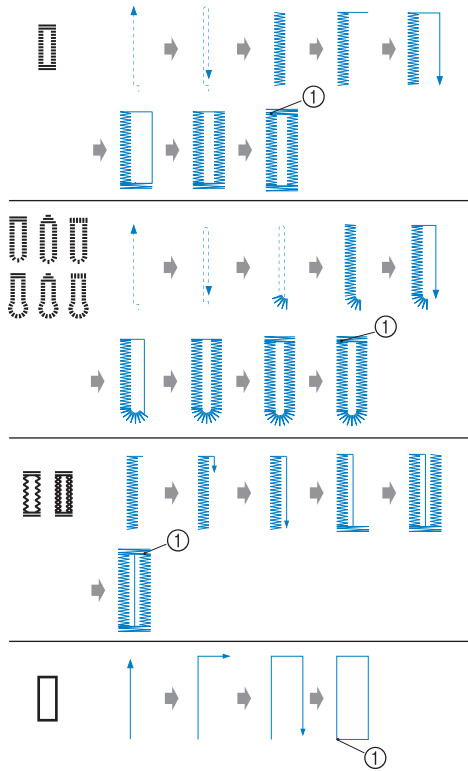

① Reinforcement stitching

The part names of buttonhole foot “A”, which is used to create buttonholes, are indicated below.

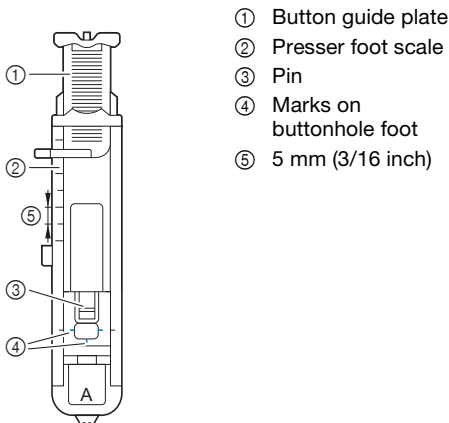

- ① Button guide plate
- ② Presser foot scale
- ③ Pin
- ④ Marks on buttonhole foot
- ⑤ 5 mm (3/16 inch)

Note

- Before sewing buttonholes, check the stitch length and width by sewing a trial buttonhole on a scrap piece of fabric used for your project.

- 1 Use chalk to mark on the fabric the position and length of the buttonhole.

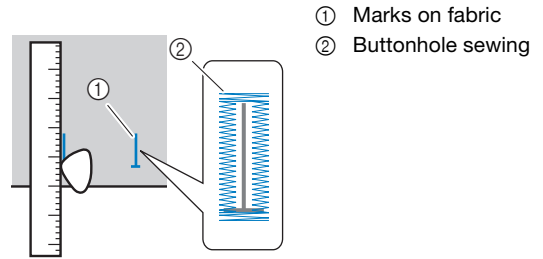

- 2 Pull out the button guide plate of buttonhole foot “A”, and then insert the button that will be put through the buttonhole.

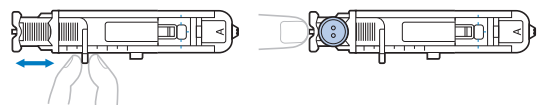

■ If the button does not fit in the button guide plate

Add together the diameter and thickness of the button, and then set the button guide plate to the calculated length. (The distance between the markings on the presser foot scale is 5 mm (3/16 inch).)

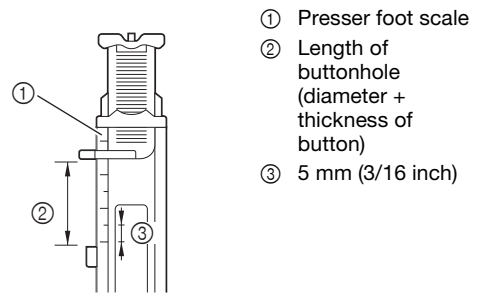

Example: For a button with a diameter of 15 mm (9/16 inch) and a thickness of 10 mm (3/8 inch), the button guide plate should be set to 25 mm (1 inch) on the scale.

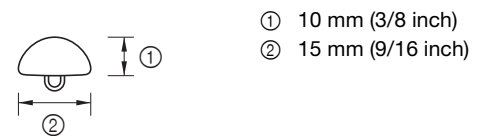

→ The size of the buttonhole is set.

- 3 Attach buttonhole foot “A”.

Position the upper thread under the presser foot by guiding thread through the hole in the presser foot before attaching the buttonhole foot “A”.

- 4 Select a stitch.

No.	4-01	4-02	4-03	4-04	4-05
Stitch					
No.	4-06	4-07	4-08	4-09	4-10
Stitch					

- For details, refer to “Stitch Chart” on page 45.

- 5** Position the fabric with the front end of the buttonhole mark aligned with the red marks on the sides of the buttonhole foot, and then lower the presser foot lever.

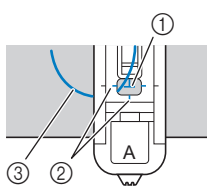

- ① Mark on fabric (front)
- ② Red marks on buttonhole foot
- ③ Upper thread

- When lowering the presser foot, do not push in the front of the presser foot.

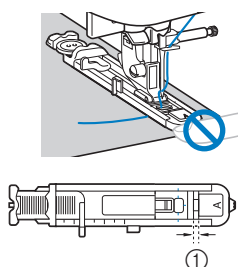

- ① Do not reduce the gap.

- 6** Pull down the buttonhole lever as far as possible.

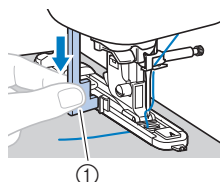

- ① Buttonhole lever

The buttonhole lever is positioned behind the bracket on the buttonhole foot.

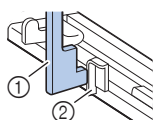

- ① Buttonhole lever
- ② Bracket

- 7** Gently hold the end of the upper thread in your left hand, and then start sewing.

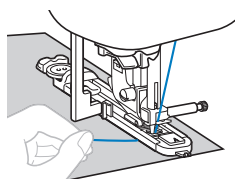

→ Once sewing is completed, the machine automatically sews reinforcement stitches, then stops.

- 8** Press  (Thread cutter button) once. Raise the presser foot, and then remove the fabric.

Memo

- When using the thread cutter on the left side of the machine or scissors to cut the threads, press  (Needle position button) to raise the needle, raise the presser foot, and then pull out the fabric before cutting the threads.

- 9** Raise the buttonhole lever to its original position.

- 10** Insert a pin along the inside of one bar tack at the end of the buttonhole stitching to prevent the stitching from being cut.

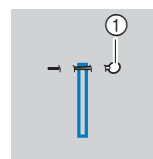

- ① Pin

- 11** Use the seam ripper to cut towards the pin and open the buttonhole.

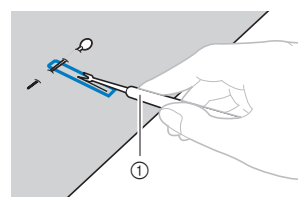

- ① Seam ripper

For keyhole buttonholes, use the eyelet punch to make a hole in the rounded end of the buttonhole, and then use the seam ripper to cut open the buttonhole.

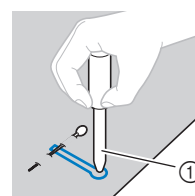

- ① Eyelet punch

- When using the eyelet punch, place thick paper or some other protective sheet under the fabric before punching the hole in the fabric.

CAUTION

- When opening the buttonhole with the seam ripper, do not place your hands in the cutting direction, otherwise injuries may result if the seam ripper slips.
- Do not use the seam ripper in any other way than how it is intended.

■ Sewing buttonholes on stretch fabrics

When sewing buttonholes on stretch fabrics, use a gimp thread.

- 1 Hook the gimp thread onto the part of buttonhole foot "A" shown in the illustration.

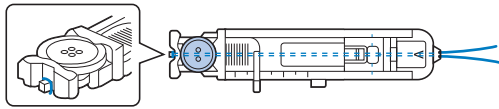

- 2 It fits into the grooves, and then loosely tie it.

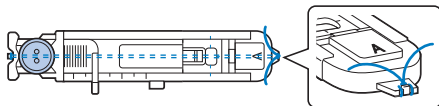

- 3 Attach buttonhole foot "A".

- 4 Select a stitch.

No.	4-05	4-06
Stitch		

- For details, refer to "Stitch Chart" on page 45.

- 5 Adjust the stitch width to the thickness of the gimp thread.

- 6 Lower the presser foot lever and the buttonhole lever, and then start sewing.

- 7 When sewing is finished, gently pull the gimp thread to remove any slack.

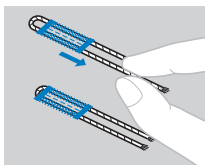

- 8 Use a handsewing needle to pull the gimp thread to the wrong side of the fabric, and then tie it.

Button sewing

Buttons can be sewn on with the machine. Buttons with two or with four holes can be attached.

- 1 Measure the distance between the holes in the button to be attached.



- 2 Remove the flat bed attachment.

- 3 Raise the presser foot lever, and then slide the feed dog position switch, located at the rear of the machine on the base, to (to the left as seen from the rear of the machine).

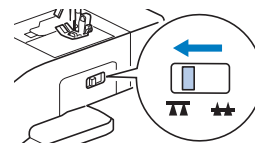

- 4 Attach button fitting foot "M".

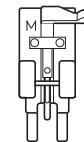

- 5 Select a stitch.

No.	4-14
Stitch	

- For details, refer to "Stitch Chart" on page 45.
- Since the end of the thread will be tied off later, do not set the machine for automatic thread cutting.

- 6 Adjust the stitch width so that it is the same as the distance between the holes in the button.

- 7 Place the button in the position where it will be sewn, and lower the presser foot lever.

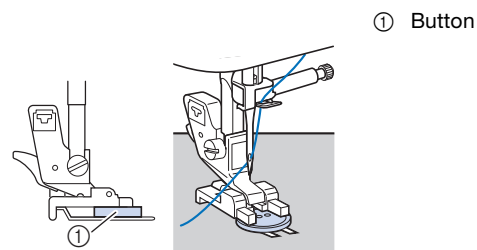

- When attaching four-hole buttons, first sew the two holes closest to you. Then, slide the button so that the needle goes into the two holes toward the rear of the machine, and then sew them in the same way.

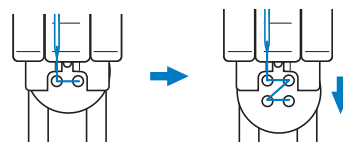

- 8** Turn the handwheel toward you (counterclockwise) to check that the needle correctly goes into the two holes of the button.

If it seems as if the needle will hit the button, remeasure the distance between the holes in the button. Adjust the stitch width to the distance between the button holes.

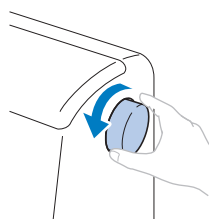

CAUTION

- When sewing, be sure that the needle does not touch the button, otherwise the needle may bend or break.

- 9** Start sewing.

Set the sewing speed controller to the left (so that the speed will be slow).

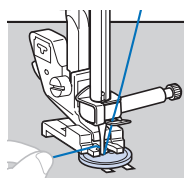



→ The machine automatically stops after sewing reinforcement stitches.

- Do not press  (Thread cutter button).

- 10** Use scissors to cut the upper thread and the bobbin thread at the beginning of the stitching.

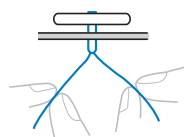
Pull the upper thread at the end of the stitching to the wrong side of the fabric, and then tie it with the bobbin thread.



- 11** When you are finished attaching the button, slide the feed dog position switch, to  (to the right as seen from the rear of the machine), turn the handwheel to raise the feed dogs and insert the flat bed attachment.

Attaching a shank to a button

To sew the button with a shank, attach the button with space between it and the fabric, and then wind the thread by hand. This attaches the button securely.

- 1** Place the button into button fitting foot “M”, and then pull the shank lever toward you.

① Shank lever

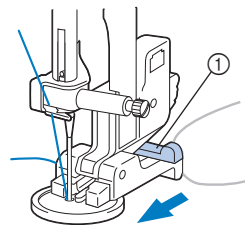

- 2** After sewing is finished, cut the upper thread with plenty of excess, wind it around the thread between the button and the fabric, and then tie it to the upper thread at the beginning of the stitching.

Tie together the ends of the bobbin thread at the end and at the beginning of the stitching at the wrong side of the fabric.

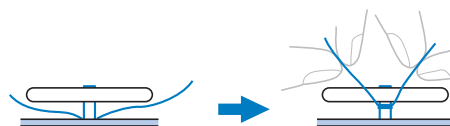

- 3** Cut off any excess thread.

Zipper insertion

Inserting a centered zipper

Stitching is sewn on both pieces of fabric butted against each other.

① Right side of fabric
② Stitching
③ End of zipper opening

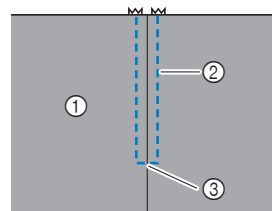

- 1** Attach zigzag foot “J”.

- 2** Sew straight stitches up to the zipper opening.

With the right sides of the fabric facing each other, sew reverse stitches after reaching the zipper opening.

① Reverse stitches
② End of zipper opening

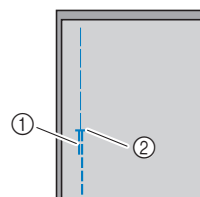

3 Using a basting stitch, continue sewing to the edge of the fabric.

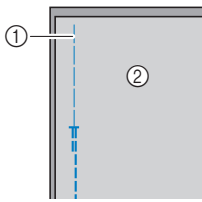

- ① Basting stitching
- ② Wrong side of fabric

4 Press open the seam allowance from the wrong side of the fabric.

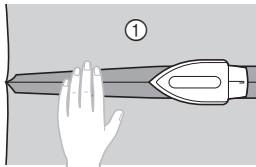

- ① Wrong side of fabric

5 Align the seam with the center of the zipper, and then baste the zipper in place to the seam allowance.

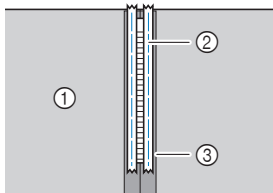

- ① Wrong side of fabric
- ② Basting stitching
- ③ Zipper

6 Remove about 5 cm (2 inches) from the end of the basting on the outside.

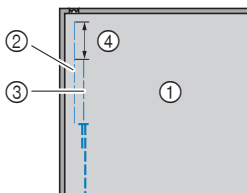

- ① Wrong side of fabric
- ② Zipper basting
- ③ Outside basting
- ④ 5 cm (2 inches)

7 Attach the presser foot holder to the right pin of zipper foot "1".

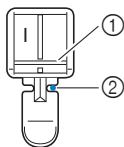

- ① Pin on the right side
- ② Needle drop point

8 Select a stitch.

No.	1-03
Stitch	

- For details, refer to "Stitch Chart" on page 45.

⚠ CAUTION

- When using zipper foot "1", be sure to select the straight stitch (middle (center) needle position), and slowly turn the handwheel toward you (counterclockwise) to check that the needle does not touch the presser foot. If a different stitch is selected or the needle hits the presser foot, the needle may bend or break.

9 Topstitch around the zipper.

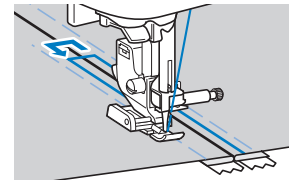
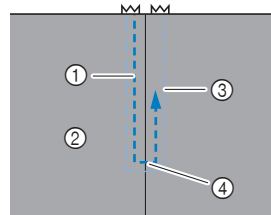

- ① Stitching
- ② Right side of fabric
- ③ Basting stitching
- ④ End of zipper opening

⚠ CAUTION

- When sewing, be sure that the needle does not touch the zipper, otherwise the needle may bend or break.

📖 Memo

- If the presser foot contacts the zipper slider, leave the needle lowered (in the fabric) and raise the presser foot. After moving the slider so it will not contact the presser foot, lower the presser foot and continue sewing.

10 Remove the basting stitching.

Zipper/piping insertion

A zipper and piping can be sewn in place.

Use adjustable zipper/piping foot (sold separately with some models)

■ Inserting a centered zipper

- 1 Refer to step 1–6 of “Inserting a centered zipper” on page 59.
- 2 Remove the presser foot and presser foot holder to attach the screw-on adjustable zipper/piping foot (sold separately with some models).
 - For details on removing the presser foot holder, refer to “Removing and attaching the presser foot holder” on page 30.

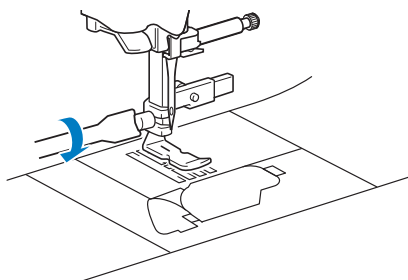

Note

- Make sure that the thread between the spool and the bobbin is pulled tight.

- 3 Select a stitch.

No.	1-01
Stitch	

- 4 Loosen the positioning screw on the back of the presser foot.

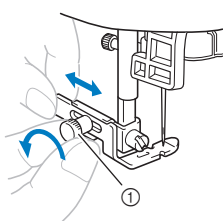

① Positioning screw

- 5 Slide the presser foot over either the left or right feed dog.

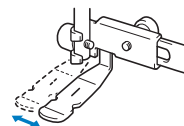

Left sewing position

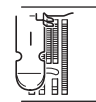

Right sewing position

- 6 Change the needle position so that the needle does not touch the presser foot.

For details, refer to “Setting the stitch width/stitch length/“L/R Shift”” on page 38.

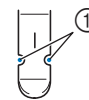

① Needle drop point

⚠ CAUTION

- After adjusting the needle position, slowly turn the handwheel toward you (counterclockwise) and check the needle does not touch the presser foot. If the needle hits the presser foot, the needle may bend or break.

- 7 Securely tighten the positioning screw.

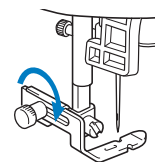

- 8 Topstitch around the zipper.

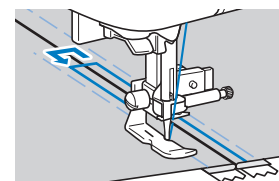
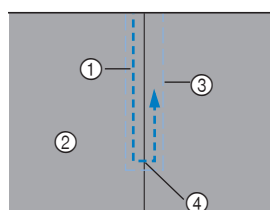

- ① Stitching
- ② Right side of fabric
- ③ Basting stitching
- ④ End of zipper opening

⚠ CAUTION

- When sewing, be sure that the needle does not touch the zipper, otherwise the needle may bend or break.

- 9 Remove the basting stitching.

■ Inserting a piping

- 1 Place the piping between two fabrics inside out, as shown below.

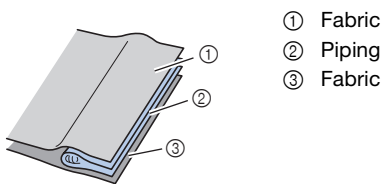

- 2 Attach the adjustable zipper/piping foot. (page 61)

- 3 Sew along the piping.

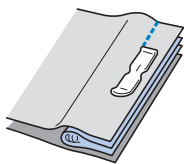

- 4 After sewing, turn them over.

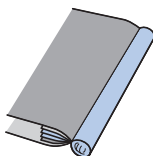

Appliqué, patchwork and quilt stitching

■ Appliqué stitching

- 1 Baste or glue the appliqué piece to the base fabric to secure it.

Note

- If glue is used to hold the appliqué in place on the fabric, do not apply glue to areas that will be sewn with the machine. If glue adheres to the needle or bobbin case, the machine may be damaged.

- 2 Attach the zigzag foot "J" or the open toe foot (sold separately with some models) shown below.

Zigzag foot "J"

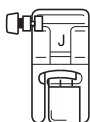

Open toe foot

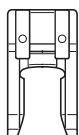

- 3 Select a stitch.

No.	1-33	1-34	2-03	2-20
Stitch				

- For details, refer to "Stitch Chart" on page 45.

- 4 Turn the handwheel toward you (counterclockwise), and then begin sewing around the edge of the appliqué, making sure that the needle drops just outside of the appliqué.

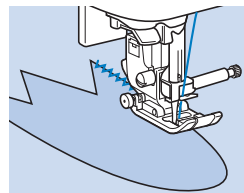

When sewing around corners, stop the machine with the needle in the fabric just outside of the appliqué, raise the presser foot lever, and then turn the fabric as needed to change the sewing direction.

■ Patchwork (crazy quilt) stitching

- 1 Fold the edge of the top piece of fabric and place it over the lower piece.

- 2 Attach zigzag foot "J".

- 3 Select a stitch.

- The stitches shown below are examples. Select the desired stitch.

No.	1-33	2-07	2-08	2-09
Stitch				

- For details, refer to "Stitch Chart" on page 45.

- 4 Sew the two pieces of fabric together so the stitch pattern spans over both pieces.

Use pins if necessary.

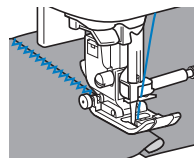

⚠ CAUTION

- Do not stitch over pins.

■ Piecing

Sewing together two pieces of fabric is called "piecing". The fabric pieces should be cut with a 6.5 mm (1/4 inch) seam allowance.

Sew a piecing straight stitch 6.5 mm (1/4 inch) from either the right side or the left side of the presser foot.

- 1 Baste or pin along the seam allowance of the fabric that you wish to piece together.

- 2 Attach zigzag foot "J".

3 Select a stitch.

No.	1-29	1-31
Stitch		

- For details, refer to "Stitch Chart" on page 45.

4 Sew with the side of the presser foot aligned with the edge of the fabric.**□ For a seam allowance on the right side**

Align the right side of the presser foot with the edge of the fabric, and sew using stitch

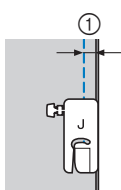

① 6.5 mm (1/4 inch)

□ For a seam allowance on the left side

Align the left side of the presser foot with the edge of the fabric, and sew using stitch

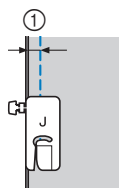

① 6.5 mm (1/4 inch)

Memo

- To change the width of the seam allowance (needle position), adjust the stitch width. For details, refer to "Setting the stitch width" on page 38 and "Sewing an even seam allowance" on page 40.

□ Using the 1/4" piecing foot (sold separately with some models)

If the 1/4" piecing foot is used, seams can be sewn with a seam allowance of 6.4 mm (1/4 inch).

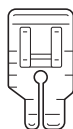
1 Baste or pin along the seam allowance of the fabric that you wish to piece together.**2 Attach the 1/4" piecing foot.****3 Select a stitch.**

No.	1-30
Stitch	

- For details, refer to "Stitch Chart" on page 45.

4 Align the mark at the upper edge of the 1/4" piecing foot with the upper edge of the fabric.

Align the right edge of the fabric with the right edge of the narrow part of the 1/4" piecing foot.

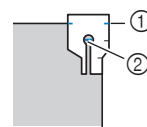

- ① Mark on 1/4" piecing foot
- ② Beginning of stitching

To topstitch 1/8" from a seam allowance, align the left edge of the narrow part of the 1/4" piecing foot with the seam allowance.

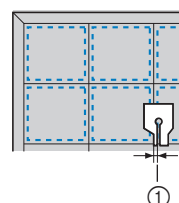

- ① Seam (3.2 mm (1/8 inch))

5 Start sewing.**6 When the end of the stitching is reached, stop the machine.**

Sew until the mark at the lower edge of the 1/4" piecing foot aligns with the lower edge of the fabric.

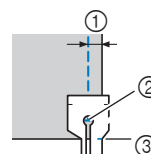

- ① 6.4mm (1/4 inch)
- ② End of stitching
- ③ Mark on 1/4" piecing foot



■ Quilting

Sandwiching batting between the top and bottom layers of fabric is called “quilting”. Quilts can easily be sewn using the walking foot* and the quilting guide*.

* Items sold separately, please contact your authorized Brother dealer.

🔔 Note

- Thread the needle manually when using the walking foot, or attach the walking foot only after threading the needle using the needle threader.
- When quilting, use a 90/14 home sewing machine needle.
- When sewing with the walking foot, sew at a speed between slow and medium.
- When using the walking foot, test sew on a scrap piece of fabric that is to be used in project.

📖 Memo

- When [Automatic Fabric Sensor System] in the settings screen is set to [ON], the thickness of the fabric is automatically detected by the internal sensor so the fabric can be fed smoothly for best sewing results. (page 36)

1 Baste the fabric to be quilted.

2 Remove the presser foot and the presser foot holder.

- For details, refer to “Removing and attaching the presser foot holder” on page 30.

3 Hook the connecting fork of the walking foot onto the needle clamp screw.

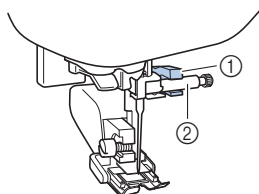

- ① Connecting fork
- ② Needle clamp screw

4 Lower the presser foot lever, and then tighten the presser foot holder screw with the screwdriver.

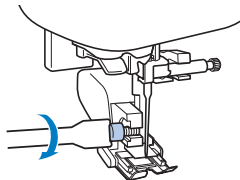

⚠ CAUTION

- Be sure to securely tighten the screws with the screwdriver, otherwise the needle may touch the presser foot, causing it to bend or break.
- Before starting to sew, slowly turn the handwheel toward you (counterclockwise) and check that the needle does not touch the presser foot. If the needle hits the presser foot, the needle may bend or break.

5 Select a stitch.

No.	1-04	1-33
Stitch		

- For details, refer to “Stitch Chart” on page 45.

6 Place one hand on each side of the presser foot, and then evenly guide the fabric while sewing.

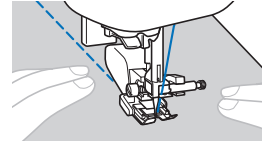

Using the quilting guide (sold separately with some models)

Use the quilting guide to sew parallel stitches that are equally spaced.

1 Insert the stem of the quilting guide into the hole at the rear of the walking foot or presser foot holder.

Walking foot

Presser foot holder

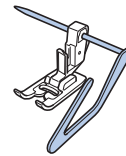
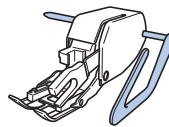

2 Adjust the stem of the quilting guide so that the guide aligns with the seam that has already been sewn.

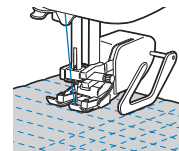

■ Free motion quilting

We recommend attaching the foot controller and sewing at a consistent speed. You can adjust the sewing speed with the speed control slide on the machine.

⚠ CAUTION

- With free motion quilting, control the feeding speed of the fabric to match the sewing speed. If the fabric is moved faster than the sewing speed, the needle may break or other damage may result.

□ Using free motion open toe quilting foot “O”

The free motion open toe quilting foot “O” is used for free motion quilting with zigzag or decorative stitches or for free motion quilting of straight lines on fabric with an uneven thickness.

Free motion open toe quilting foot “O”

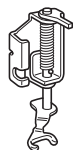

- 1 Remove the flat bed attachment, and then slide the feed dog position switch, located at the rear of the machine on the base, to (to the left as seen from the rear of the machine).

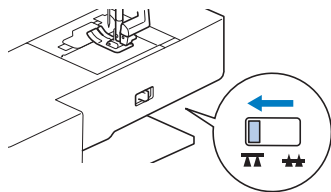

→ The feed dogs are lowered.

- 2 Select a stitch.

No.	1-04	1-33
Stitch		

- For details, refer to “Stitch Chart” on page 45.

- 3 Press to display the editing screen, and then press to set the machine to the free motion mode.

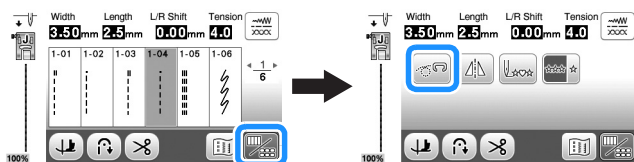

→ The key appears as and the presser foot is raised to the best height for free motion sewing.

- 4 Remove the presser foot holder.

- For details, refer to “Removing and attaching the presser foot holder” on page 30.

- 5 Attach the quilting foot by positioning the pin of the quilting foot above the needle clamp screw and aligning the lower-left of the quilting foot and the presser bar.

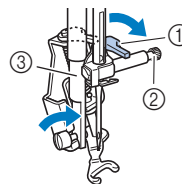

- ① Pin
- ② Needle clamp screw
- ③ Presser bar

Note

- Make sure that the quilting foot is not slanted.

- 6 Hold the quilting foot in place with your right hand, and tighten the presser foot holder screw using the screwdriver with your left hand.

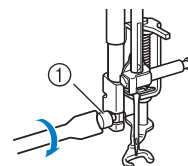

- ① Presser foot holder screw

⚠ CAUTION

- Be sure to securely tighten the screws with the included screwdriver. Otherwise, the needle may touch the quilting foot, causing it to bend or break.

- 7 Use both hands keeping the fabric taut, and then move the fabric at a consistent pace in order to sew uniform stitches roughly 2.0 mm - 2.5 mm (approx. 1/16 inch - 3/32 inch) in length.

- ① Stitch

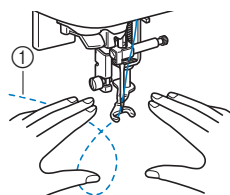

- 8 After sewing is finished, slide the feed dog position switch lever to (to the right as seen from the rear of the machine), turn the handwheel to raise the feed dogs and insert the flat bed attachment.

- 9 Press to turn the free motion mode off.

■ Satin stitching using the sewing speed controller

A decorative stitch can be sewn by changing the stitch width of a satin stitch. If the machine is set so that the stitch width can be adjusted using the sewing speed controller, the stitch width can quickly and easily be adjusted.

- 1 **Connect the foot controller.**
- 2 **Attach zigzag foot “J”.**
- 3 Press  and set [Width Control] (page 1 of the settings screen) to [ON].



→ The machine is now set so that the stitch width can be controlled with the sewing speed controller.

- 4 **Select a stitch.**

No.	1-33
Stitch	

- For details, refer to “Stitch Chart” on page 45.

Memo

- Although the stitching results differ depending on the type of fabric being sewn and the thickness of the thread being used, for best results, adjust the stitch length to between 0.3 and 0.5 mm (1/64 and 1/32 inch).

- 5 **While sewing, slide the sewing speed controller to adjust the stitch width.**

- Adjust the sewing speed with the foot controller.

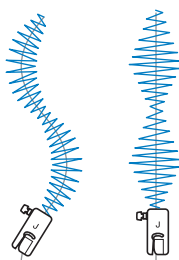

- 6 **When you are finished sewing, set [Width Control] back to [OFF].**

Other stitching applications

■ Elastic attaching



When elastic tape is attached to the cuff or waist of a piece of clothing, the finished dimensions will be that of the stretched elastic tape. Therefore, it is necessary that a suitable length of the elastic tape be used.

- 1 **Pin the elastic tape to the wrong side of the fabric.**
Pin the elastic tape to the fabric at a few points to make sure that the tape is uniformly positioned on the fabric.



- 2 **Attach zigzag foot “J”.**

- 3 **Select a stitch.**

No.	1-13	1-14	2-13
Stitch			

- For details, refer to “Stitch Chart” on page 45.

- 4 **Sew the elastic tape to the fabric while stretching the tape so that it is the same length as the fabric.**

While pulling the fabric behind the presser foot with your left hand, pull the fabric at the pin nearest the front of the presser foot with your right hand.

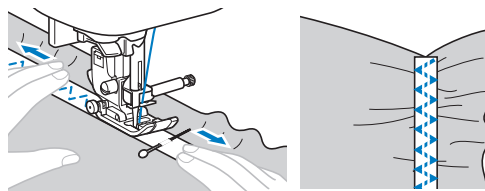

CAUTION

- When sewing, be sure that the needle does not touch any pins, otherwise the needle may bend or break.

■ Bar tack stitching

Bar tacks are used to reinforce points subject to strain, such as pocket corners and openings.

As an example, the procedure for sewing bar tacks at pocket corners is described below.

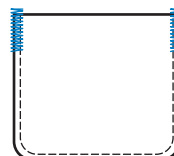

1 Determine the desired length of the bar tack.

Set the button guide plate on buttonhole foot "A" to the desired length. (The distance between the markings on the presser foot scale is 5 mm (3/16 inch).)

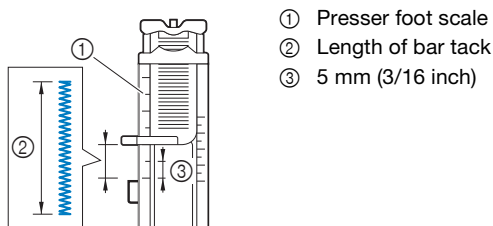

- ① Presser foot scale
- ② Length of bar tack
- ③ 5 mm (3/16 inch)

- A bar tack with a maximum length of about 28 mm (1-1/8 inches) can be sewn.

2 Attach buttonhole foot "A".

Position the upper thread under the presser foot by guiding thread through the hole in the presser foot before attaching the buttonhole foot "A".

3 Select a stitch.

No.	4-13
Stitch	

- For details, refer to "Stitch Chart" on page 45.

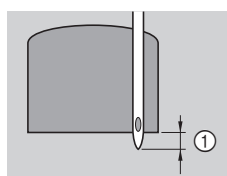
4 Position the fabric so that the opening of the pocket faces toward you, and then lower the presser foot lever so that the needle drops 2 mm (1/16 inch) in front of the pocket opening.

- ① 2 mm (1/16 inch)

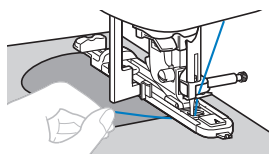
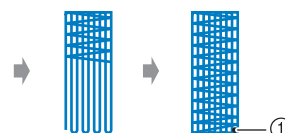
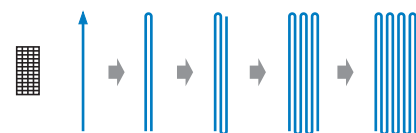
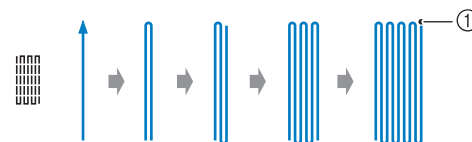
5 Pull down the buttonhole lever as far as possible.**6 Gently hold the end of the upper thread in your left hand, and then start sewing.****7 After sewing is finished, raise the presser foot lever, remove the fabric, and then cut the threads.****8 Raise the buttonhole lever to its original position.****■ Darning**

- ① Reinforcement stitching

1 Determine the desired length of the darning.

Set the button guide plate on buttonhole foot "A" to the desired length. (The distance between the markings on the presser foot scale is 5 mm (3/16 inch).)

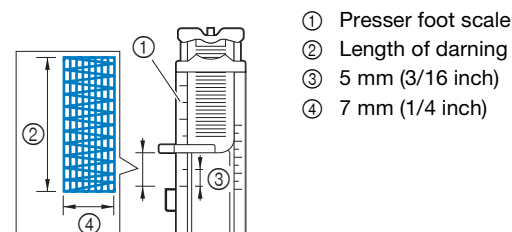

- ① Presser foot scale
- ② Length of darning
- ③ 5 mm (3/16 inch)
- ④ 7 mm (1/4 inch)

- A bar tack with a maximum length of about 28 mm (1-1/8 inches) can be sewn.

→ Once sewing is completed, the machine automatically sews reinforcement stitches, then stops.

2 Attach buttonhole foot "A".

Position the upper thread under the presser foot by guiding thread through the hole in the presser foot before attaching the buttonhole foot "A".

3 Select a stitch.

No.	4-11	4-12
Stitch		

- For details, refer to "Stitch Chart" on page 45.

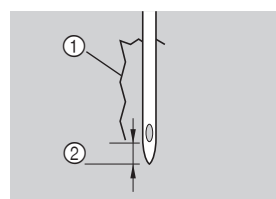
4 Position the fabric so that the needle is 2 mm (1/16 inch) in front of the area to be darned, and then lower the presser foot.

- ① Tear
- ② 2 mm (1/16 inch)

- 5 Pull down the buttonhole lever as far as possible.
- 6 Gently hold the end of the upper thread in your left hand, and then start sewing.

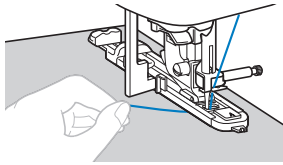

- 7 After sewing is finished, raise the presser foot lever, remove the fabric, and then cut the threads.
- 8 Raise the buttonhole lever to its original position.

■ Eyelet stitching

Eyelets, such as those on belts, can be sewn.

- 1 Attach monogramming foot “N”.

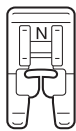

- 2 Select a stitch.

No.	4-15
Stitch	

- For details, refer to “Stitch Chart” on page 45.

- 3 Adjust either the stitch width or the stitch length to select the desired eyelet size.

- For details, refer to “Setting the stitch width” on page 38 and “Setting the stitch length” on page 38.

- 4 Lower the needle into the fabric at the beginning of the stitching, and then lower the presser foot lever.

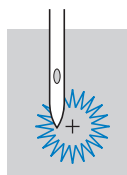

- 5 Start sewing.

→ Once sewing is completed, the machine automatically sews reinforcement stitches, then stops.

- 6 After removing the fabric, use the eyelet punch to cut a hole in the center of the eyelet.

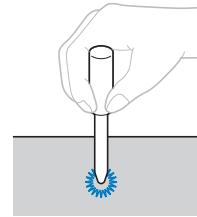

- When using the eyelet punch, place thick paper or some other protective sheet under the fabric before punching the hole in the fabric.

■ Fagoting

Stitching across an open seam is called “fagoting”. It is used on blouses and children’s clothing. This stitch is more decorative when thicker thread is used.

- 1 Use an iron to fold the two pieces of fabric along their seams.
- 2 Baste the two pieces of fabric, separated by about 4 mm (3/16 inch), onto thin paper or a sheet of water-soluble stabilizer.

If you draw a line down the middle of the thin paper or water-soluble stabilizer, sewing is easier.

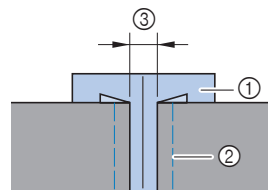

- ① Thin paper or water-soluble stabilizer
- ② Basting stitching
- ③ 4 mm (3/16 inch)

- 3 Attach zigzag foot “J”.
- 4 Select a stitch.

No.	2-11	2-12
Stitch		

- For details, refer to “Stitch Chart” on page 45.

- 5 Set the stitch width to 7.0 mm (1/4 inch).
- 6 Sew with the center of the presser foot aligned along the center of the two pieces of fabric.

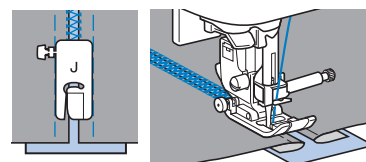

- 7 After sewing is finished, remove the paper.

■ Scallop stitching

The wave-shaped repeated stitch pattern that looks like shells is called “scalloping”. It is used on the collars of blouses and to decorate the edges of projects.

1 Attach monogramming foot “N”.

2 Select a stitch.

No.	2-05
Stitch	

• For details, refer to “Stitch Chart” on page 45.

3 Stitch along the edge of the fabric, making sure not to sew directly on the edge of the fabric.

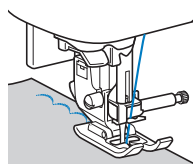

4 Trim along the stitches.

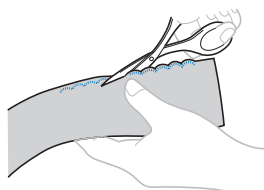

• Be careful not to cut the stitches.

■ Smocking

The decorative stitch created by stitching or embroidering over gathers is called “smocking”. It is used to decorate the front of blouses or cuffs.

The smocking stitch adds texture and elasticity to fabric.

1 Attach zigzag foot “J”.



2 Select the straight stitch, and then adjust the stitch length to 4.0 mm (3/16 inch) and loosen the thread tension.

3 Sew parallel stitching at intervals of 1 cm (3/8 inch) and pull the bobbin threads to create gathers.

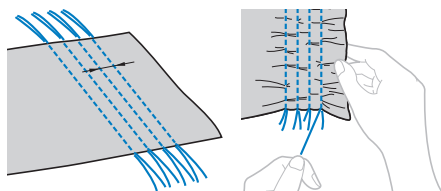
Smooth the gathers by ironing them.



4 Select a stitch.

No.	2-10	2-11	2-12
Stitch			

• For details, refer to “Stitch Chart” on page 45.

5 Stitch between the straight stitches and pull out the threads for the straight stitches.

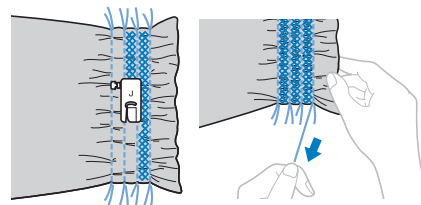

■ Shell tuck stitching

The gathers that look like shells are called “shell tucks”. They are used to decorate trims, the front of blouses or cuffs made of thin fabrics.

1 Draw equally spaced lines along the bias, and then fold the fabric along the lines.

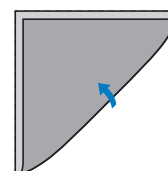

2 Attach zigzag foot “J”.

3 Select a stitch, and then increase the thread tension.

No.	2-04
Stitch	

• For details, refer to “Stitch Chart” on page 45.

4 Sew while making sure that the needle drops slightly off the edge of the fabric.

One fold at a time, continue folding the fabric along the line, then sewing it.

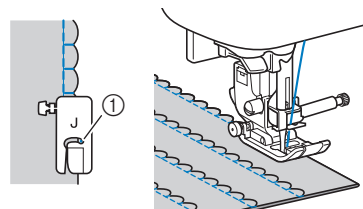

① Needle drop point



5 After sewing is finished, remove the fabric. Unfold the fabric, and then iron the tucks down to one side.

Joining





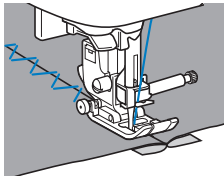



Decorative bridging stitches can be sewn over the seam allowance of joined fabrics. This is used when making a crazy quilt.

- 1 Attach zigzag foot "J".
 - 2 Sew together the right sides of the two pieces of fabric, and then open up the seam allowances.
 - 3 Select a stitch.
- | | | | |
|--------|---|---|---|
| No. | 2-07 | 2-08 | 2-09 |
| Stitch |  |  |  |
- For details, refer to "Stitch Chart" on page 45.
- 4 Turn the fabric over so that the right side faces up, and then sew over the seam with the center of the presser foot aligned with the seam.



Multi-directional sewing (straight stitch and zigzag stitch)



Use these stitch patterns to attach patches or emblems to pant legs, shirt sleeves, etc.

No.	5-01	5-02	5-03	5-04
Stitch				
No.	5-05	5-06	5-07	5-08
Stitch				

• For details, refer to "Stitch Chart" on page 45.

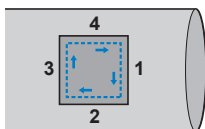
Insert the tubular piece of fabric onto the free-arm, and then sew in the order shown in the illustration.

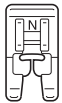

- 1 Remove the flat bed attachment.
 - 2 Attach monogramming foot "N".
- 
- 3 Select stitch .

- 4 Lower the needle into the fabric at the beginning of the stitching, and then start sewing.

Lower the needle at the upper-right corner.

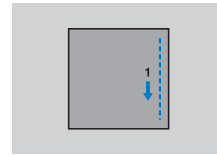

→ The fabric is fed toward the back of the machine, as usual.

- 5 After you have sewn to the corner, stop the machine, and then select stitch .

- 6 Start sewing.

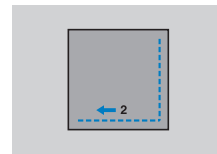

→ The fabric is fed to the right.

- 7 After you have sewn to the corner, stop the machine, and then select stitch .

- 8 Start sewing.

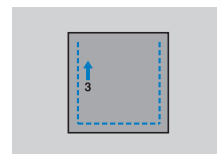

→ The fabric is fed forward.

- 9 After you have sewn to the corner, stop the machine, and then select stitch .

- 10 Start sewing.

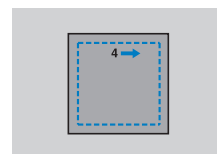

→ The fabric is fed to the left.

- 11 After you have sewn to the corner, stop the machine, and then select stitch  again.

- 12 After sewing 3 to 5 stitches at the beginning of the stitching, stop the machine.

Memo

- The feeding direction of the fabric differs depending on the stitch that is selected. Be sure to guide the fabric while machine is sewing.

■ Using the twin needle

With the twin needle, you can sew two parallel lines of the same stitch with two different threads. Both upper threads should have the same thickness and quality.

⚠ CAUTION

- Only use the twin needle (2/11 needle), and never use the needle threader with the twin needle. Otherwise, the needle may break or the machine may be damaged.

- 1 Press  and install the twin needle.

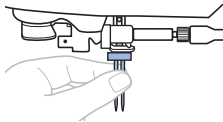

- For details on installing a needle, refer to “Replacing the Needle” on page 28.

- 2 Pass the first upper thread behind the needle bar thread guide.

- For details, refer to steps 1 through 9 of “Threading the upper thread” on page 24.

- 3 Manually thread the left needle with the first upper thread.

Pass the thread through the eye of the needle from the front.

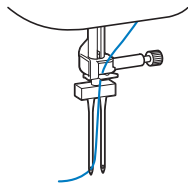

- 4 Insert the horizontal spool pin onto the bobbin winder shaft.

Insert the spool pin so that it is perpendicular to the bobbin winder shaft.

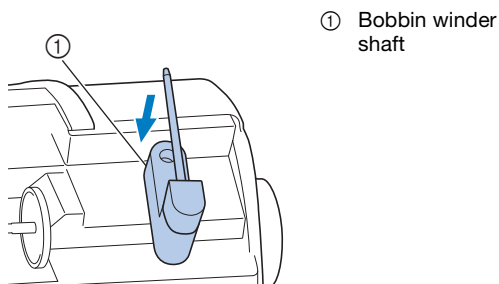

- 5 Swing the spool pin toward the left so that it is horizontal.

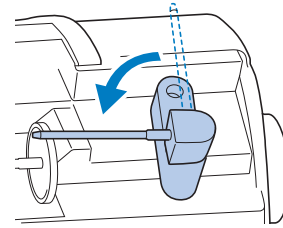

- 6 Place the upper thread spool for the needle on the right side onto the spool pin, and then secure it with the spool cap.

The thread should unwind from the front at the bottom of the spool.

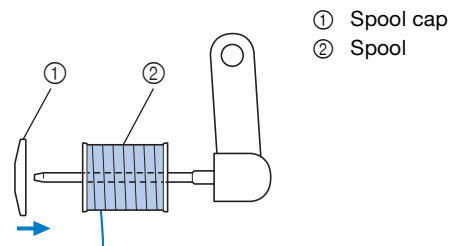

- 7 Thread the upper thread in the same way that the upper thread for the left side was threaded.

- 8 Without passing the thread through the needle bar thread guide, manually thread the right needle.

Insert the thread through the eye of the needle from the front to the back.

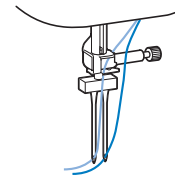

- 9 Attach zigzag foot “J”.

- For details on changing the presser foot, refer to “Replacing the presser foot” on page 29.

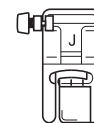

⚠ CAUTION

- When using the twin needle, be sure to attach zigzag foot “J”. If bunched stitches occur, use monogramming foot “N” or attach stabilizer material.

- 10 Press  to unlock all keys and buttons.

11 Press  and set [Twin Needle] (page 1 of the settings screen) to [ON].



CAUTION

- When using the twin needle, be sure to select the twin needle setting, otherwise the needle may break or the machine may be damaged.

12 Select a stitch.

- Refer to “Stitch Chart” on page 45 for stitches that use a twin needle. You can also sew with a twin needle when you select a 7 mm satin stitch pattern. In this case, use zigzag foot “J”.

CAUTION

- When using the twin needle, be sure to select an appropriate stitch, otherwise the needle may break or the machine may be damaged.

13 Start sewing.

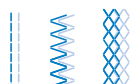

CAUTION

- Do not try turning the fabric while the twin needle is down in the fabric, otherwise the needle may break or the machine may be damaged.

Heirloom stitching

When sewing with the wing needle, the needle holes are enlarged, creating a lace-like decorative stitch. This is used to decorate hems and tablecloths on thin or medium weight fabrics in addition to plain weave fabrics.









1 Install the wing needle.



- Use a 130/705H 100/16 wing needle.
- For details on installing a needle, refer to “Replacing the needle” on page 28.
- The needle threader cannot be used with the wing needle, otherwise the machine may be damaged. Manually pass the thread through the eye of the needle from the front to the back.

2 Attach monogramming foot “N”.

3 Select a stitch.

No.	3-04	3-06	3-9	3-10
Stitch				
No.	3-12	3-18	3-20	3-21
Stitch				
No.	3-22			
Stitch				

- For details, refer to “Stitch Chart” on page 45.

CAUTION

- When sewing with the wing needle, select a stitch width of 6.0 mm (15/64 inch) or less, otherwise the needle may bend or break.
- After adjusting the stitch width, slowly turn the handwheel toward you (counterclockwise) and check that the needle does not touch the presser foot. If the needle hits the presser foot, the needle may bend or break.

4 Start sewing.

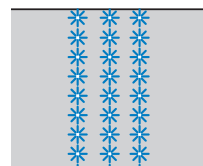

Making step stitch patterns

You can use the   keys to create a step effect.

Stitch patterns sewn so that they create a step effect are called step stitch patterns.

Press these keys to shift the stitch pattern to the left or right by half width of the stitch pattern.

□ Example:



1 Press .

2 Select a stitch.

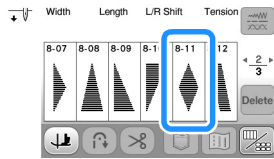

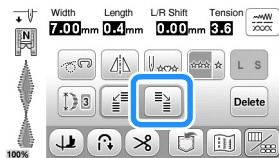

3 Press  to display editing screen, and then press .



→ The next stitch pattern will move to the right.



4 Press  to display the previous screen, and select the same stitch again.

5 Press  to display editing screen again, and then press .

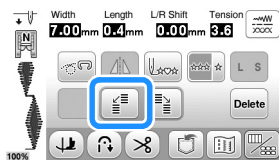

→ The next stitch pattern will move to the left.





6 Press .

→ The entered stitch pattern is repeated.



Making Adjustments

Your stitch pattern may sometimes turn out poorly, depending on the type or thickness of fabric, the stabilizer material used, sewing speed, etc. If your sewing does not turn out well, sew trial stitches using the same conditions as the real sewing, and adjust the stitch pattern as explained below. If the stitch pattern does not turn out well even after making adjustments based on the stitch pattern described below, make adjustments for each stitch pattern individually.

Memo

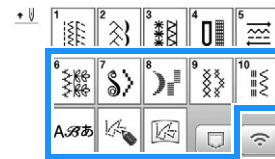
- This adjustment can be made to  (1-35 Quilting stippling stitch),  (4-15 eyelet stitch) and stitch patterns from the following categories.



1 Press  and select  (6-80).

2 Attach monogramming foot "N" and sew the stitch pattern.

Note

- Be sure to use monogramming foot "N". Adjustments may not be made correctly with any other presser foot.

3 Compare the finished stitch pattern to the illustration of the correct stitch pattern below.

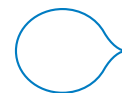

4 Press , and then adjust the stitch pattern with the [Fine Adjust Vert.] or [Fine Adjust Horiz.] displays. (page 1 of the settings screen)



If the stitch pattern is bunched:

Press  in the [Fine Adjust Vert.] display.

→ The displayed value increases each time the key is pressed and the stitch pattern will lengthen.

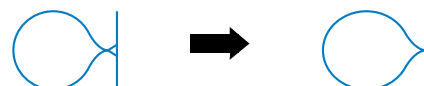

□ **If the stitch pattern has gaps:**

Press **-** in the [Fine Adjust Vert.] display.

→ The displayed value decreases each time the key is pressed and the stitch pattern will shorten.

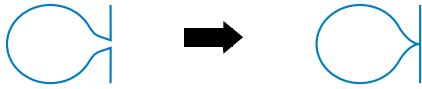

□ **If the stitch pattern is skewed to the left:**

Press **+** in the [Fine Adjust Horiz.] display.

→ The displayed value increases each time the key is pressed and the stitch pattern will slide to the right.



□ **If the stitch pattern is skewed to the right:**

Press **-** in the [Fine Adjust Horiz.] display.

→ The displayed value decreases each time the key is pressed and the stitch pattern will slide to the left.



5 **Sew the stitch pattern again.**

- If the stitch pattern still comes out poorly, make adjustments again. Adjust until the stitch pattern comes out correctly.

6 Press **OK** to return to the original screen.

Using the Memory Function

■ **Stitch data precautions**

□ **Types of stitch data that can be used**

In the Character/Decorative Stitch memory, “.pmv”, “.pmx” and “.pmu” stitch data files can be used with this machine. “.pmu” or “.pmx” stitch data files can be retrieved; however, when the machine is used to save the file, it is saved as a “.pmv” stitch data file. Using data other than what was created using this machine or the machine which create “.pmv”, “.pmx” or “.pmu” data file, may cause the machine to malfunction.

□ **USB flash drive**

USB flash drive is commercially available, but some USB flash drives may not be usable with this machine. Please visit our website “<http://s.brother/cpham/>” for more details.

□ **Precautions when using the computer to save data**

- We recommend using the 26 letters of the alphabet (uppercase and lowercase), the numbers 0 through 9, “-”, and “_” for the name of the file/folder.

Saving stitch patterns

You can save stitch patterns that you have customized in the machine's memory or USB flash drive.

Note

- Do not turn the main power to OFF while the [Saving...] screen is displayed. You will lose the stitch pattern you are saving.

- Press .

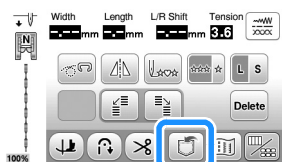

- When saving the stitch pattern in a USB flash drive, insert the USB flash drive into the USB port on the machine.

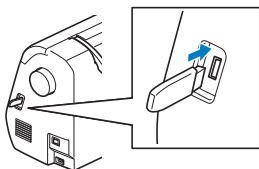

- Press the desired destination to start saving.

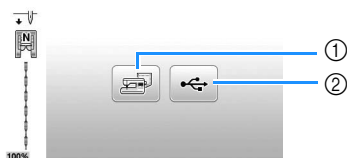

- Save to the machine's memory.
- Save to the USB flash drive. The stitch pattern is saved in a folder labeled "bPocket".

Retrieving stitch patterns

Retrieve stitch patterns saved in the machine's memory or USB flash drive.

- When retrieving stitch patterns from a USB flash drive, insert the USB flash drive into the USB port on the machine.
- Press .

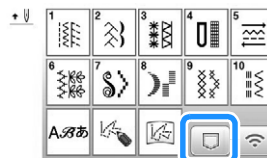

- Press the desired destination.



- Retrieve from the machine's memory.
- Retrieve from a USB flash drive.

Memo

- If the stitch pattern to be retrieved is in a folder of the USB flash drive, press the key for that folder. Press  to return to the previous screen.

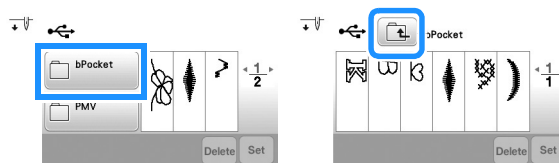

- Folders in the USB flash drive cannot be created with the machine.

- Select the desired stitch pattern, and then press .

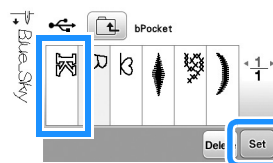

Memo

- When you press , the selected stitch pattern will be deleted permanently.

MY CUSTOM STITCH

■ Designing a stitch

By using the MY CUSTOM STITCH function, you can register stitches you have created yourself. You can also sew designs combining MY CUSTOM STITCH creations with built-in characters (page 31).

📖 Memo

- Stitches that you create with MY CUSTOM STITCH can be a maximum of 7 mm (approx. 9/32 inch) wide and 37 mm (approx. 1-1/3 inches) long.

- 1 **Draw the stitch design on the grid sheet. Place points where the stitch pattern intersects with the grid, and connect all the points with a line.**

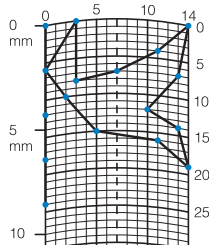

📖 Memo

- Simplify the design so that it can be sewn as a continuous line. For a more attractive stitch, close the design by intersecting lines.



If the design is to be repeated and linked, the start point and end point of the design should be at the same height.

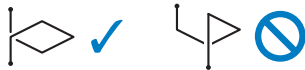

- 2 **Determine the x and y coordinates of each of the marked points.**

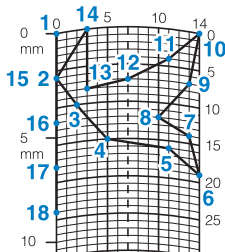

■ MY CUSTOM STITCH screen

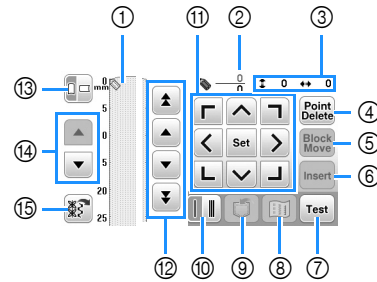

- ① This area displays the stitch being created.
- ② Displays the number of the present set point over the total number of points in the stitch.
- ③ Displays the y-coordinate of over the x-coordinate of .

No.	Display Key Name	Explanation	Page
④		Press this key to delete a selected point.	-
	Point delete key		
⑤		Press this key to group points together and move them together.	77
	Block move key		
⑥		Press this key to insert new points on the stitch design.	77
	Insert key		
⑦		Press this key to sew a test of the stitch.	-
	Test key		
⑧		Press this key to view an image of the stitch.	-
	Image key		
⑨		Press this key to store the stitch being created.	77
	MY CUSTOM STITCH memory key		
⑩		Press this key to select whether one or three stitches will be sewn between two points.	77
	Single/triple stitching key		
⑪		Use these keys to move over the display area, and press the set key in the center to set a point on the stitch design.	77
	Arrow keys and set key		
⑫		Use these keys to move from point to point on the stitch, or to the first or last point entered on the stitch.	77
	Point-to-point key		
⑬		Press this key to change the direction of the grid sheet.	-
	Grid direction key		
⑭		Press this key to scroll the grid sheet.	-
	Page scroll key		
⑮		Press this key to display built-in sample stitch pattern that can be edited.	-
	Sample stitch pattern retrieve key		

■ Entering points

1 Press .



2 Use to move to the coordinates of the first point on the grid sheet.
Press to add the point indicated by .

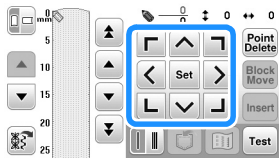

3 Select whether a single stitch or triple stitches will be sewn between the first two points.

- To sew triple stitches, press the key so that it appears as .

4 Repeat the steps for each point that you have drawn on the grid sheet until the stitch design is drawn on the screen as a continuous line.

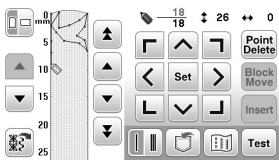

5 Once you finish entering the stitch data, press to save the stitch pattern.

■ Moving a point

1 Press to move to the point that you want to move.

2 Use to move the point.

3 Press to determine the position.

■ Moving part or all of the design

1 Press to move to the first point of the section that you want to move.

2 Press .

→ The selected point and all points that were entered after it are selected.

3 Press to move the section and press .

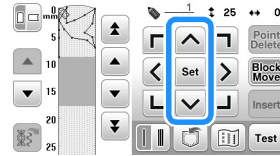

→ The section will be moved.

■ Inserting new points

1 Press to move to a place on the design where you want to add a new point.

2 Press .

3 Use to move the point.

4 Press to insert the point.

■ Retrieving saved stitch patterns

1 Press to select the location of the stitch pattern to be retrieved.



2 Select the stitch pattern.

3 Press to retrieve the stitch pattern.

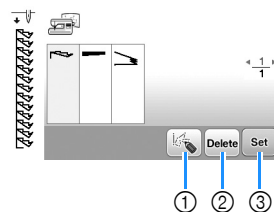

- Edit the stitch pattern.
- Delete the stitch pattern.
- Retrieve the stitch pattern.

Chapter 4 EMBROIDERY

Embroidering Preparation

Follow the steps below to prepare the machine for embroidery.

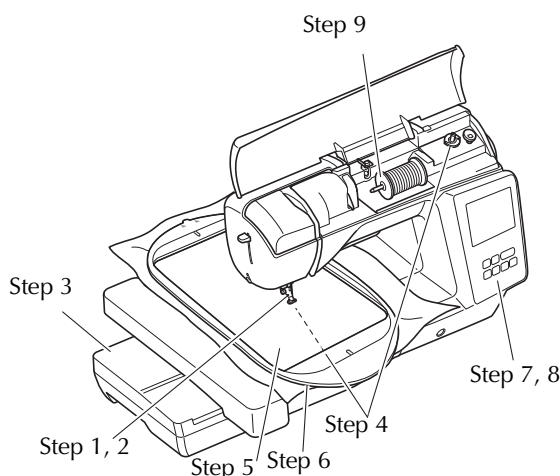

Step #	Aim	Action	Page
1	Presser foot attachment	Attach embroidery foot "U".	79
2	Checking the needle	Use needle for embroidery.	28
3	Embroidery unit attachment	Attach the embroidery unit.	80
4	Bobbin thread setup	For the bobbin thread, wind embroidery bobbin thread and set it in place.	20
5	Fabric preparation	Attach a stabilizer material to the fabric, and hoop it in the embroidery frame.	82
6	Embroidery frame attachment	Attach the embroidery frame to the embroidery unit.	84
7	Pattern selection	Select an embroidery pattern.	85
8	Checking the layout	Check and adjust the size and position of the embroidery.	88
9	Embroidery thread setup	Set up embroidery thread according to the pattern.	89

Attaching the embroidery foot

⚠ CAUTION

- Be sure to use embroidery foot when doing embroidery. Using another presser foot may cause the needle to strike the presser foot, causing the needle to bend or break and possibly cause injury.

- 1 Press (Needle position button) to raise the needle.
- 2 Press .
 - When the message [OK to automatically lower the presser foot?] appears on the LCD screen, press to continue.
 - The screen changes, and all keys and operation buttons are locked (except).
- 3 Remove the presser foot and presser foot holder.
 - For details, refer to "Replacing the Presser Foot" on page 29.

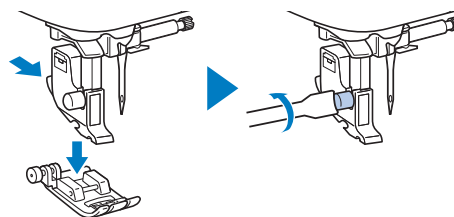

- 4 Attach embroidery foot "U" so that the presser foot holder screw fits into the notch in the foot.

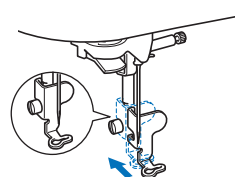

- Make sure that embroidery foot "U" is vertical when it is installed.

- 5 Hold the embroidery foot in place with your right hand, and then use the included screwdriver to securely tighten the presser foot holder screw.

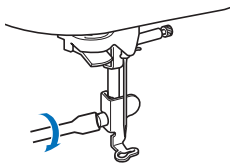

⚠ CAUTION

- Use the included screwdriver to firmly tighten the screw of the embroidery foot. If the screw is loose, the needle may strike the presser foot and possibly cause injury.

- 6 Press to unlock all keys and buttons.

Attaching the embroidery unit

⚠ CAUTION

- Before attaching the embroidery unit, be sure to turn off the machine. Otherwise, injuries may occur if one of the operation buttons is accidentally pressed and the machine starts embroidering.
- Do not move the machine with the embroidery unit in place. The embroidery unit may be dropped and cause injury.
- Keep your hands and other objects away from the embroidery carriage and frame when they are moving. Otherwise injury may result.

- 1 Turn off the machine.
- 2 Pull the flat bed attachment off to the left.

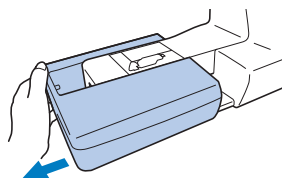

- 3 Slide the tab on the cover of the connection port in the direction of the arrow to open the cover.

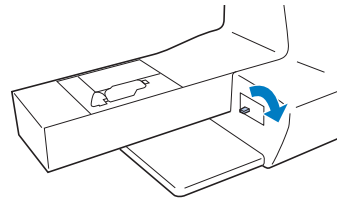

Note

- Be sure to close the cover of the connection port when the embroidery unit is not being used.

- 4 Insert the embroidery unit connection into the connection port, and then lightly push in the embroidery unit until it snaps into place.

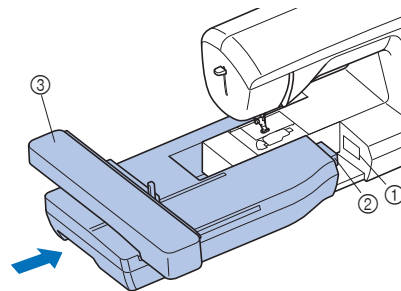

- ① Connection port
- ② Embroidery unit connection
- ③ Carriage

Note

- Make sure that there is no gap between the embroidery unit and the machine, otherwise the embroidery pattern may not be embroidered correctly. Be sure to fully insert the connector into the connection port.
- Do not push on the carriage when attaching the embroidery unit to the machine, otherwise damage to the embroidery unit may result.
- Do not touch the connector in the embroidery unit connection slot. The connector could be damaged, and it may cause malfunctions.
- Do not lift up on the embroidery carriage, and do not forcefully move it. It may cause malfunctions.

- 5 Turn on the machine.
→ A message appears in the screen.

Note

- If [Opening Screen] is set [ON] within the settings screen, touch screen for the following message to appear.

- 6 Be sure that no objects or hands are near the embroidery unit and press .





- The carriage moves to its initial position.
- The screen for selecting the embroidery pattern type is displayed.

Memo

- Utility stitches cannot be selected when the embroidery unit is attached.

■ Removing the embroidery unit

Make sure that the machine is completely stopped and follow the instructions below.

- 1 **Remove the embroidery frame.**
 - For details on removing the embroidery frame, refer to “Removing the embroidery frame” on page 85.
- 2 Press , and then press .

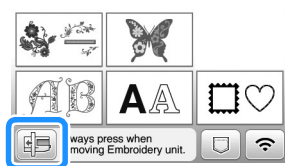

- The embroidery carriage moves into a position where it can be stored.

- 3 **Turn off the machine.**

CAUTION

- Always turn off the machine before removing the embroidery unit. It may cause malfunctions if removed when the machine is turned on.

- 4 **Hold the release button on the bottom left of the embroidery unit, and slowly pull the embroidery unit to the left.**

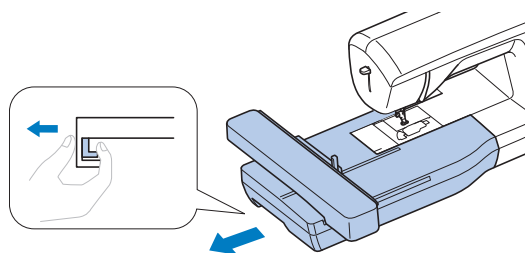

Embroidering attractive finishes

There are many factors that go into beautiful embroidery. Using the appropriate stabilizer (page 82) and hooping the fabric in the frame (page 82) are two important factors mentioned earlier. Another important point is the appropriateness of the needle and thread being used. See the explanation of threads below.

■ Thread

Upper thread	Use embroidery thread intended for use with this machine. Other embroidery threads may not yield optimum results.
Bobbin thread	Use the included 60 weight embroidery bobbin thread or recommended 60 weight embroidery bobbin thread.

■ Bobbin case

Two types of bobbin cases are included with this machine. When embroidering, use the appropriate bobbin case depending on the bobbin thread that will be used. See the explanation of bobbin case types below.

Standard bobbin case (recommended for sewing and for embroidering with included 60 weight bobbin thread)

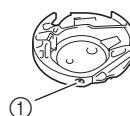

- ① Standard bobbin case (green marking on the screw)

The standard bobbin case originally installed in the machine has a green marking on the tension adjustment screw. We recommend using the included embroidery bobbin thread with this bobbin case. Do not adjust the tension screw on this bobbin case with the green marked screw.

Alternate bobbin case (for prewound or other embroidery bobbin threads)

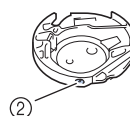

- ② Alternate bobbin case (no color on the screw)

The alternate bobbin case with no color on the tension adjustment screw is set with tighter tension for embroidery with different weights of bobbin threads and a variety of embroidery techniques. This bobbin case is identified with a dark colored mark on the inside of the bobbin cavity. The tension screw on this case can be adjusted if necessary. For details on adjusting thread tension, refer to “Adjusting thread tension” on page 91.

- Refer to “Cleaning the race” on page 103 for how to remove the bobbin case.

⚠ CAUTION

- When embroidering on large garments (especially jackets or other heavy fabrics), do not let the fabric hang off the table. Otherwise, the embroidery unit cannot move freely and the embroidery frame may strike the needle, causing the needle to bend or break and possibly cause injury. Place the fabric so that it does not hang off the table or hold the fabric to keep it from dragging.

💡 Note



- Do not leave objects in the range of motion of the embroidery frame. The frame may strike the object and cause a poor finish to the embroidery pattern.
- When embroidering on large garments (especially jackets or other heavy fabrics), do not let the fabric hang off the table. Otherwise, the embroidery unit cannot move freely, and the pattern may not turn out as planned.

Hooping the fabric in the embroidery frame

⚠ CAUTION

- Use fabrics with a thickness of less than 2 mm (1/16 inch). Using fabrics thicker than 2 mm (1/16 inch) may cause the needle to break.
- Always use a stabilizer material for embroidery when embroidering stretch fabrics, lightweight fabrics, fabrics with a coarse weave, or fabrics which cause pattern shrinkage. Otherwise, the needle may break and cause injury.

💡 Note

- Press . In the [Embroidery Foot Height], use  and  in the settings screen. Adjust the presser foot height for thick or puffy fabrics.

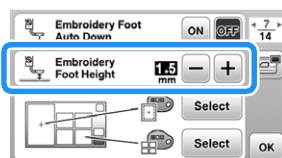

- To increase the space between the presser foot and the needle plate, set the embroidery foot height to a larger number, 1.5 mm setting is used for most embroidery.

■ Attaching iron-on stabilizers (backing) to the fabric

For best results in your embroidery projects, always use stabilizer material for embroidery.

1 Press the iron-on stabilizer material to the wrong side of the fabric.

- Use a piece of stabilizer which is larger than the embroidery frame being used.

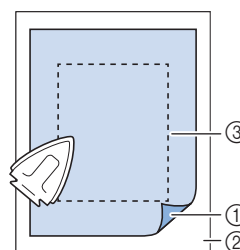

- ① Fusible side of stabilizer
- ② Fabric (wrong side)
- ③ Size of the embroidery frame

📖 Memo

- When embroidering small pieces of fabric that cannot be hooped on an embroidery frame, use stabilizer material as a base. After lightly ironing the fabric to the stabilizer material, hoop it in the embroidery frame. If stabilizer material cannot be ironed onto the fabric, attach it with a basting stitch. After completing the embroidery, remove the stabilizer material carefully.

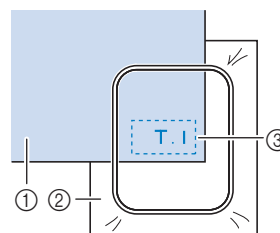

- ① Fabric
- ② Stabilizer
- ③ Basting

- When embroidering on thin fabrics such as organdy or lawn, or on napped fabrics such as terry cloth or corduroy, use water soluble stabilizer (sold separately) for best results. The water soluble stabilizer material will dissolve completely in water, giving the project a more attractive finish.
- In the case of thick terry cloth towels we recommend that you place a piece of water soluble stabilizer on the top surface of the towel. This will help to reduce the nap of the toweling and result in more attractive embroidery.
- When using fabrics that cannot be ironed (such as terry cloth or fabrics that have loops which expand when ironed) or in places where ironing is difficult, position the stabilizer material under the fabric without fusing it, then position the fabric and stabilizer in the embroidery frame, or check with your authorized Brother dealer for the correct stabilizer to use.

■ Inserting the fabric

⚠ CAUTION

- If you use a frame that is too small, the presser foot may strike the frame during embroidering and cause injury or may damage your machine.

💡 Note

- If the fabric is not securely held in the embroidery frame, the embroidery pattern will stitch poorly. Insert the fabric on a level surface, and gently pull the fabric taut in the frame, being careful not to distort hooped fabric.

- 1 Lift-up and loosen the frame adjustment screw and remove the inner frame.

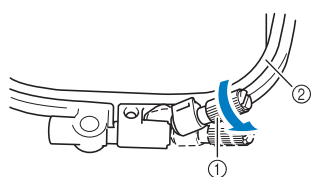

- ① Frame adjustment screw
- ② Inner frame

- 2 Lay the fabric right side up on top of the outer frame. Re-insert the inner frame making sure to align the inner frame's \triangle with the outer frame's ∇ .

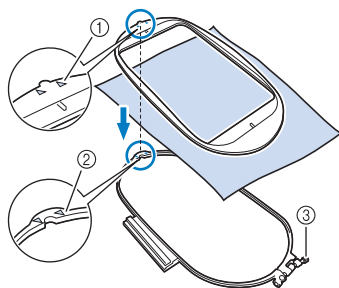

- ① Inner frame's \triangle
- ② Outer frame's ∇
- ③ Frame adjustment screw

- 3 Slightly tighten the frame adjustment screw, and then remove the slack in the fabric by gently pulling on the edges and corners. Do not loosen the screw.

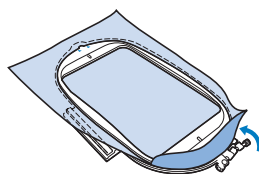

- 4 Gently stretch the fabric taut, and tighten the frame adjustment screw to keep the fabric from loosening after stretching.

- After stretching the fabric, make sure the fabric is taut.

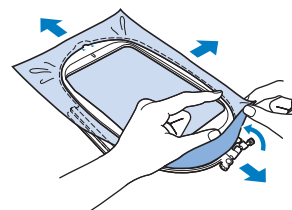

- Make sure the inside and outside frames are even before you start embroidering.

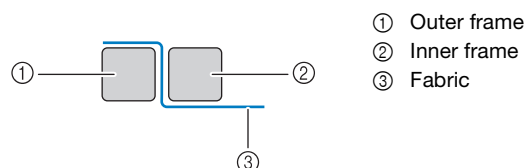

📖 Memo

- After stretching the fabric, lightly tapping it should produce a drum-like sound.
- Stretch the fabric from all four corners and all four edges. While stretching the fabric, tighten the frame adjustment screw.

- 5 Return the frame adjustment screw to its initial position.

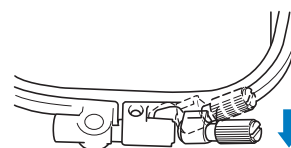

📖 Memo

- You can use the included screwdriver when you loosen or tighten the frame adjustment screw.

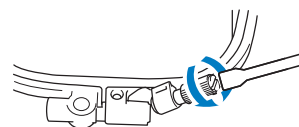

■ Using the embroidery sheet

When you want to embroider the pattern in a particular place, use the embroidery sheet with the frame.

- 1 With a chalk pencil, mark the area of the fabric you want to embroider.

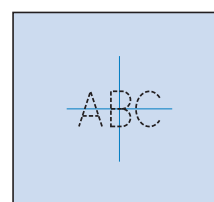

- 2 Place the embroidery sheet on the inner frame.
- 3 Line the mark on the fabric up with the base line on the embroidery sheet.

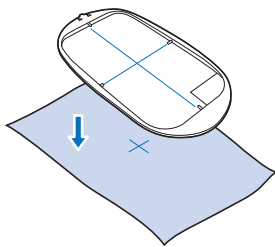

- 4 Place the inner frame with the fabric on the outer frame and adjust the fabric if needed to align marks on fabric with the embroidery sheet.
- 5 Remove the embroidery sheet.

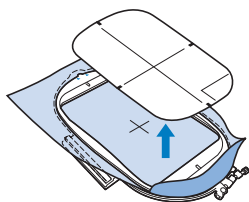

Attaching the embroidery frame

Note

- Wind and insert the bobbin before attaching the embroidery frame making sure to use the recommended bobbin thread. Check that there is enough thread in the bobbin.

- 1 Press  (Presser foot lifter button) to raise the presser foot.
- 2 Raise the frame-securing lever.

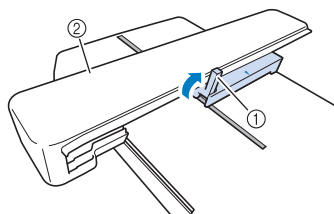

- 1 Frame-securing lever
- 2 Carriage

- 3 Align the embroidery frame guide with the right edge of the embroidery frame holder.

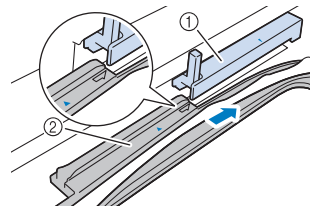

- 1 Embroidery frame holder
- 2 Embroidery frame guide

- 4 Slide the embroidery frame into the holder, making sure to align the embroidery frame's arrow mark with the one on holder.

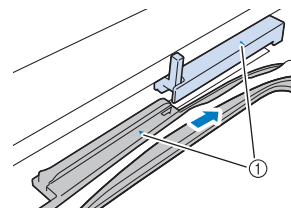

- 1 Arrow mark

- 5 Lower the frame-securing lever to be level with the frame to secure the embroidery frame in the embroidery frame holder.

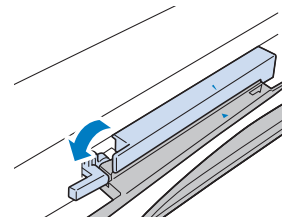

CAUTION

- If the frame-securing lever is not lowered, the following message appears. You cannot start embroidering until you lower the frame-securing lever.

Make sure embroidery frame is moved as far back as possible. LOCK DOWN THE FRAME-SECURING LEVER.

OK

■ Removing the embroidery frame

1 Press  (Presser foot lifter button) to raise the presser foot.

2 Raise the frame-securing lever.

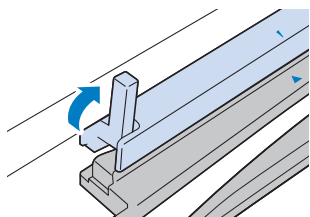

3 Pull the embroidery frame toward you.

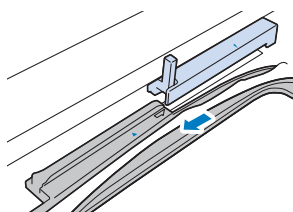

Embroidering

■ Copyright information

The patterns stored in the machine are intended for private use only. Any public or commercial use of copyrighted patterns is an infringement of copyright law and is strictly prohibited.

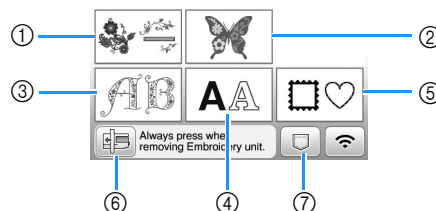

■ Embroidery pattern types



- ① Embroidery patterns
- ② Brother "Exclusives"
- ③ Floral alphabet patterns
- ④ Character patterns
- ⑤ Frame patterns
- ⑥ Press this key to position the embroidery unit for storage
- ⑦ Patterns saved in the machine's memory, patterns saved in USB flash drive, or patterns transferred via wireless network. (page 101)

- Refer to the "Embroidery Design Guide" for more information on each category's embroidery pattern.

Selecting an embroidery pattern

1 Press  in the pattern type selection screen, and then press .

- If the pattern type selection screen is not displayed, press  to display the screen below.

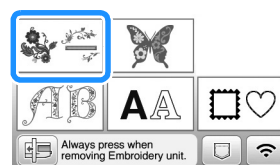

2 Press  or  to display the desired pattern on the screen.

3 Select a desired embroidery pattern, and then press



- Available frame options are displayed on the screen.

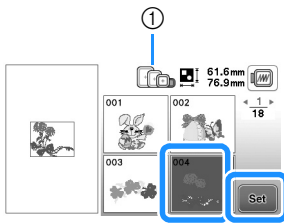

- ① White: Frame which can be used with the selected pattern
- Gray: Frame which cannot be used with the selected pattern

→ Pattern editing screen appears.

4 Press

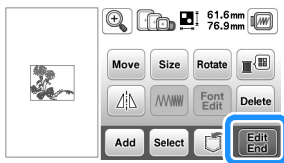

- For details on pattern editing screen, refer to “Editing Patterns (Pattern Editing Screen)” on page 96. You can move the pattern, change the size of pattern, and perform many other editing operations.
- The pattern can also be moved by dragging it with your finger.

→ Embroidery settings screen appears.

5 Press

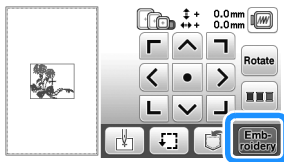

- For details on embroidery settings screen, refer to “Editing Patterns (Embroidery Settings Screen)” on page 98.
- Confirm the pattern position to be embroidered, referring to “Checking the pattern position” on page 88.

Memo

- If [Embroidery Frame Identification View] in the settings screen is set to [ON], the pattern can be edited in the screen as if that embroidery frame is attached.

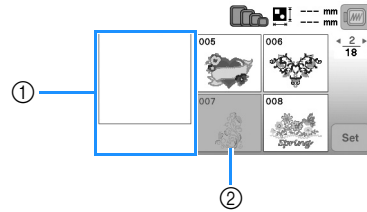
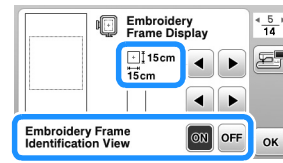

- ① The embroidering area for the selected frame is displayed.
- ② Patterns that will not fit in the selected frame appear shaded and cannot be selected.

- There are three embroidery area sizes for embroidery frame (small). When [Embroidery Frame Identification View] is set to [ON] for embroidery frame (small), the area for arranging patterns can more easily be seen. The area outside of the embroidering area will have a different background color.

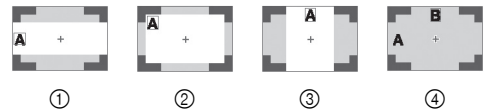

- ① 2 cm × 6 cm (approx. 1 inch (H) × 2-1/2 inches (W))
- ② 3 cm × 5 cm (approx. 1-1/8 inches (H) × 2 inches (W))
- ③ 4 cm × 3 cm (approx. 1-1/2 inches (H) × 1-1/8 inches (W))
- ④ Patterns are arranged outside of the embroidering area.

■ Selecting character patterns

- 1 Press **AA**.
- 2 Press the key of the font you want to embroider.
- 3 Press a tab to display the desired selection screen, and then type in the text.



- To enter a space, press **[]**.
- After selecting a character if you would like to change the character size press **[LMS]**. The size changes each time you press the key, from large to medium to small. After the character size is changed, all characters on the same line will have the new character size.
- If you make a mistake, press **Delete** to erase the mistake.
- To check all entered characters, for example, when there are multiple text lines, press **Check**.
- To add multiple lines, press **[↵]**.
- When the Japanese font is selected, the text can be switched between being written vertically and horizontally by pressing **[H/V]**.

- 4 Press **Set**.

- For details on editing the pattern, refer to “Editing Patterns (Pattern Editing Screen)” on page 96.

■ Selecting frame patterns

- 1 Press **[□♥]**.
- 2 Press the key of the frame shape you want to embroider.

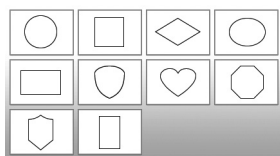

- 3 Press the key of the frame pattern you want to embroider.

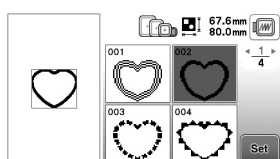

- 4 Press **Set**.

- For details on editing the pattern, refer to “Editing Patterns (Pattern Editing Screen)” on page 96.

■ Combining patterns

- 1 Select the pattern and then press **Set**.

- 2 Edit the pattern if needed, and then press **Add**.

- For details on pattern editing, refer to “Pattern editing screen” on page 96.

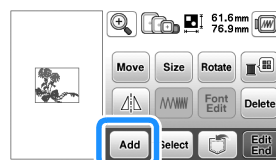

- 3 Press **AA** to enter the alphabet characters.

- 4 Select **[ABC]** and enter “Happy”.



- 5 Press **Set**.

- 6 Press **Font Edit** and then select **Array**.



- For details on character editing, refer to “Font editing screen” on page 97.

- 7 Change the layout of the characters and then press **OK** two times to return to the pattern editing screen.

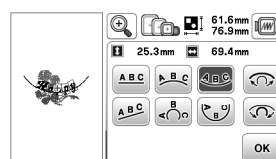

- 8 Press **[Color]** to change the color.

- 9 Change the color of the characters and then press **OK**.

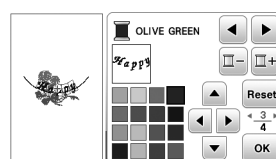

- For details on changing colors, refer to “Pattern editing screen” on page 96.

10 Edit the pattern position.

- The pattern can be selected with your finger and then moved by dragging it. Use **Select** to select patterns that are overlapping and cannot be selected by touching the screen.
- Press **Move** to decide the pattern position carefully.
- Press **Embroidery** to check the preview of the combined patterns.

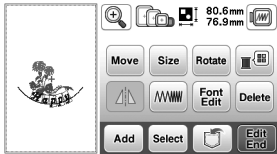

11 Press **Edit End.**

Checking the pattern position

The embroidery frame moves and shows the pattern position. Watch the frame closely to make sure the pattern will be embroidered in the right place.

1 Press **Embroidery on the embroidery settings screen.**

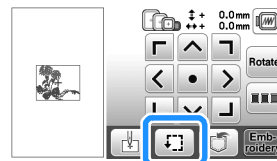

2 From the directional pad, press the key for the position that you want to check.

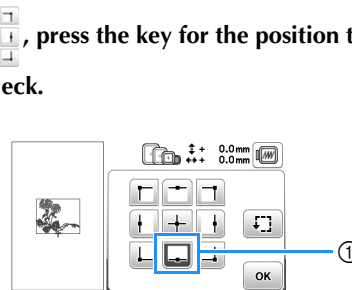

- ① Selected position
→ The carriage will move to the selected position on the pattern.

Memo

- To see the entire embroidering area, press **Embroidery**. The embroidery frame moves and shows the embroidery area.

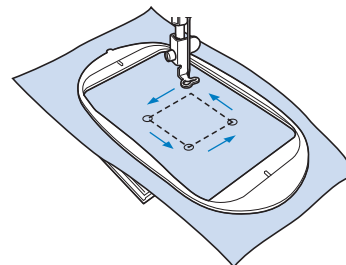

CAUTION

- Make sure the needle is up when the embroidery frame is moving. If the needle is down, it could break and result in injury.

3 Press **OK, and then press **Embroidery**.**

Embroidering a pattern

Embroidery patterns are embroidered with a change of thread after each color.

- 1 Prepare embroidery thread colors as shown on the screen.

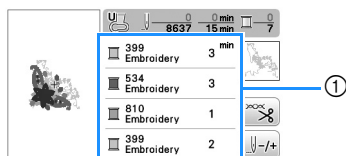

- 1 Embroidery color order

- Either the thread color name or the thread number appears in this screen, depending on the setting selected in the settings screen. Press to change the setting in the settings screen. For details, refer to "Changing the thread color display" on page 90.

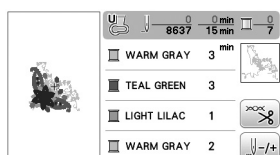

- The automatic thread cutting function will cut the thread at the end of embroidering each color. This function is initially turned on. To turn this function off, press key, and then press .

- 2 Set the embroidery thread, and thread the needle.

- Refer to "Threading the upper thread" on page 24.

- 3 Raise the presser foot lever and pass the thread through the embroidery foot hole, and hold it lightly in your left hand.

Give the thread a little slack.

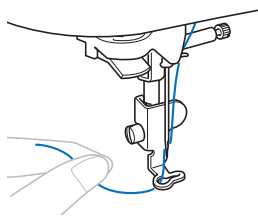

⚠ CAUTION

- Do not let hands or objects hit the carriage while embroidering. The pattern may misalign.
- When embroidering on large garments (especially jackets or other heavy fabrics), do not let the fabric hang off the table. Otherwise, the embroidery unit cannot move freely and the embroidery frame may strike the needle, causing the needle to bend or break and possibly cause injury. Place the fabric so that it does not hang off the table or hold the fabric to keep it from dragging.

- 4 Lower the presser foot, then press the "Start/Stop" button to start embroidering. After 5-6 stitches, press the "Start/Stop" button again to stop the machine.

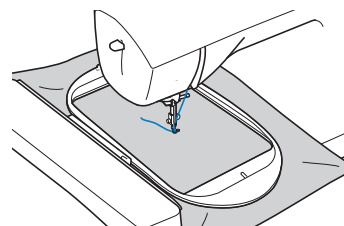

- 5 Trim the excess thread at the end of the seam. If the end of the seam is under the presser foot, raise the presser foot, then trim the excess thread.

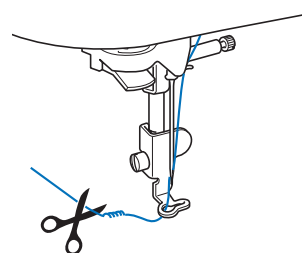

- If the thread is left at the beginning of the stitching, it may be embroidered over as you continue embroidering the pattern, making it very difficult to remove the excess thread after the pattern is finished. Trim the thread at the beginning.

- 6 Press the "Start/Stop" button to start embroidering.

→ Stitching stops automatically with reinforcement after one color has been completed. When automatic thread cutting is set, the thread is cut.

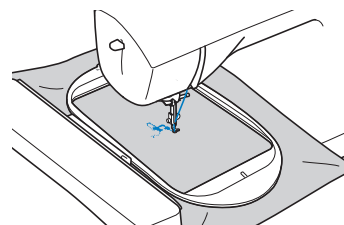

- 7 Remove the thread for the first color from the machine.

- 8 Repeat the same steps for embroidering the remaining colors.

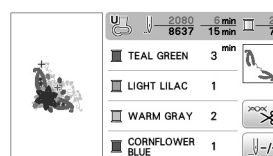

→ When the last color is embroidered, a message informing you the embroidering is finished will appear on the display. Press , and the display will return to the initial screen.

- 9 Cut the excess thread jumps within the color.

■ Changing the thread color display

You can display the name of the thread colors or embroidery thread number.

Memo

- Colors on the screen may vary slightly from actual spool colors.
- [Original], imported data remains the brand thread created with the software, is set as a default.

1 Press and use or to display the following settings screen.



2 Use or of the #123 ABC menu to select [Name of Color] or [#123] (thread number).



- When [Name of Color] is selected, the name of the thread colors is displayed.

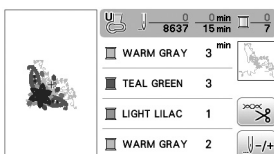

- When [#123] is selected, the embroidery thread number is displayed. Use or of the #123 menu to select the thread brand.

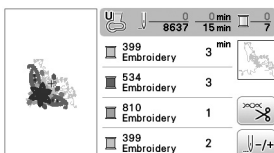

3 Press .

■ If the bobbin runs out of thread

When the bobbin begins to run out of thread during embroidering, the machine will stop and the message below will appear. Press and follow the directions below to replace the bobbin. If very little sewing remains, you can embroider approximately 10 final stitches without rethreading the machine by pressing . The machine will stop after sewing approximately 10 stitches.

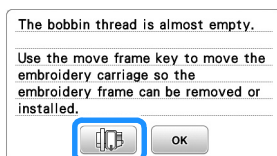

1 Press .

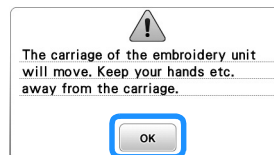

→ After the thread is automatically cut, the carriage will move.

2 Unlock the frame-securing lever and remove the embroidery frame.

- Be careful not to apply strong force to the fabric at this time. Otherwise, the fabric may loosen in the frame.

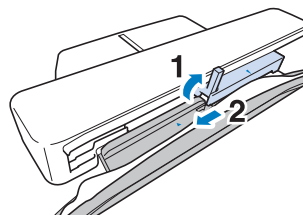

3 Insert a wound bobbin into the machine. (Refer to "Installing the bobbin" on page 22.)

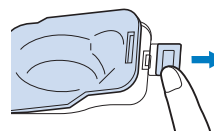

4 Attach the embroidery frame.

5 Press .

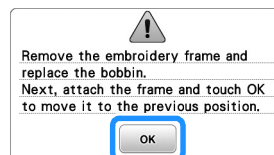

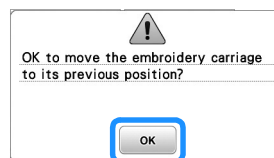

6 Press .



7 To return to the area in the pattern where you stopped sewing, follow steps 3 through 6 in the next section.

■ If the thread breaks during sewing



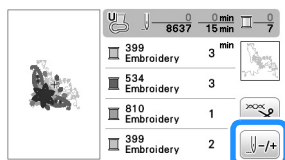

- 1 Press the “Start/Stop” button to stop the machine.
- 2 If the upper thread is broken, redo the upper threading. If the bobbin thread is broken, press  and follow the directions in steps 1 through 6 from the previous section to reset the bobbin.
- 3 Press .

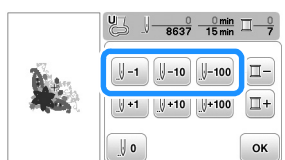



- 4 Press , , or  to move the needle back the correct number of stitches before the area where the thread broke.



Memo

- If you cannot move back to the area where the thread broke, press  to select the color and move to the beginning position of that color, then use ,  or  to move ahead to slightly before where the thread broke.

- 5 Press  to return to the original screen.
- 6 Press  (Presser foot lifter button) to lower the presser foot, and press the “Start/Stop” button to continue sewing.

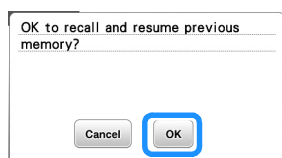

■ Resuming embroidery after turning off the power

The current color and stitch number are saved when embroidery is stopped. The next time the machine is turned on, you have the option to continue or delete the pattern.



Embroidery foot auto down

You can choose a setting to automatically lower the embroidery foot at the beginning of embroidering.

- 1 Press  to display the settings screen, and then display page 7 by pressing / .
- 2 Set [Embroidery Foot Auto Down] to [ON].

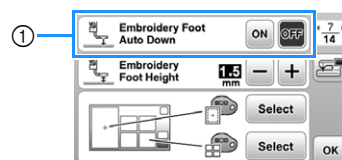



- ① When set to [ON], pressing the “Start/Stop” button when the presser foot is raised automatically lowers the presser foot before starting embroidering.

Adjusting thread tension

The upper thread tension is changed.

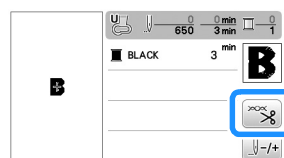
- 1 Press .



- 2 Press  to loosen the upper thread tension. (The tension number will decrease.)
Press  to tighten the upper thread tension. (The tension number will increase.)

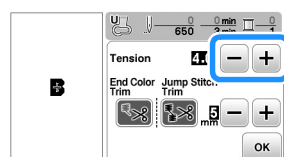

- 3 Press .

■ Correct thread tension

The thread tension is correct when upper thread is just visible on the wrong side (bottom) of the fabric.

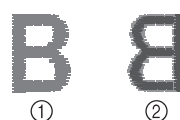

- ① Right side (top) of fabric
- ② Wrong side (bottom) of fabric

■ Upper thread is too tight

The bobbin thread will be visible on the right side (top) of the fabric. In this instance, decrease the upper thread tension.

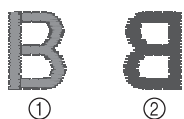

- ① Right side (top) of fabric
- ② Wrong side (bottom) of fabric

■ Upper thread is too loose

The upper thread has slack. In this instance, increase the upper thread tension.

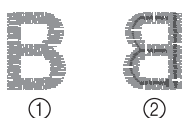

- ① Right side (top) of fabric
- ② Wrong side (bottom) of fabric

Note

- If the upper thread is not threaded correctly or the bobbin is not installed correctly, it may not be possible to set the correct thread tension. If the correct thread tension cannot be achieved, rethread the upper thread and insert the bobbin correctly.
- With [Embroidery Tension] on the setting screen, the tension of the upper thread can be adjusted for embroidering. The selected setting will be applied to all patterns.
When embroidering, if the overall tension of the upper thread is too tight or too loose, adjust it from the setting screen. Press **+** to tighten the upper thread tension and press **-** to loosen the upper thread tension. If an individual embroidery pattern needs additional fine tuning, refer to “Adjusting thread tension” on page 91.



Adjusting the bobbin case (with no color on the screw)

The bobbin case (with no color on the screw) can be adjusted when bobbin tension changes are required to accommodate different bobbin threads. Refer to “Embroidering attractive finishes” on page 81.

To adjust the bobbin tension for embroidery function, using the bobbin case (with no color on the screw), turn the slotted-head screw (-) with a screwdriver (small).

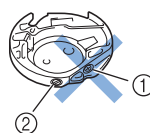

- ① Do not turn the phillips screw (+).
- ② Adjust with a screwdriver (small).

■ Correct tension

Upper thread slightly appears on the wrong side of fabric.

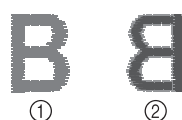

- ① Right side
- ② Wrong side

■ Bobbin thread is too loose

Bobbin thread appears slightly on the right side of fabric.

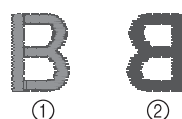

- ① Right side
- ② Wrong side

If this occurs, turn the slotted-head screw (-) clockwise, being careful not to over-tighten the screw, approximately 30-45 degrees to increase bobbin tension.

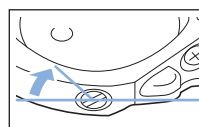

■ Bobbin thread is too tight

Upper thread on the right side of fabric seems to be lifting/looping and bobbin thread is not seen on the wrong side of fabric.

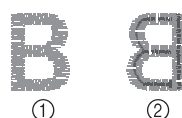

- ① Right side
- ② Wrong side

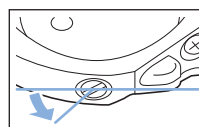

If this occurs, turn the slotted-head screw (-) counterclockwise, being careful not to over-loosen the screw, approximately 30-45 degrees to decrease bobbin tension.



⚠ CAUTION

- When adjusting the bobbin case, be sure to remove the bobbin from the bobbin case.
- **DO NOT** adjust the position of the phillips (+) screw on the bobbin case as this may result in damage to the bobbin case, rendering it unusable.
- If the slotted-head screw (-) is difficult to turn, do not use force. Turning the screw too much or providing force in either (rotational) direction may cause damage to the bobbin case. Should damage occur, the bobbin case may not maintain proper tension.

Using the automatic thread cutting function (End Color Trim)

The automatic thread cutting function will cut the thread at the end of embroidering each color. This function is initially turned on. To turn this function off, press  key and then .

- 1 Press .

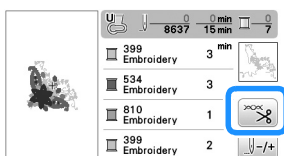

- 2 Press  to turn off the automatic thread cutting function.

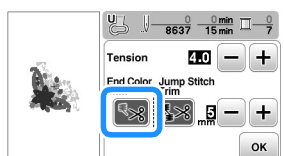



→ The key will display as .

- When one color thread is embroidered, the machine will stop without cutting the thread.

- 3 Press  to return to the original screen.

Using the thread trimming function (Jump Stitch Trim)

The thread trimming function  will automatically trim any excess thread jumps within the color. Embroidery frame (small) cannot be used. This function is initially turned on. To turn this function off, press  key and then .

* Your customized setting remains after turning the machine off and on.

⚠ CAUTION

- The carriage of the embroidery unit will move. Keep your hands etc. away from the carriage. Otherwise injury may result.





Note

- When this function is turned on, use a ball point needle 75/11 for embroidering patterns (sold separately) with short jump stitches such as alphabet characters. Using other needles may cause the thread to break.

■ Selecting the Length of Jump Stitch Not to Trim

When the thread trimming function  is turned on, you can select the length at which jump stitch trimming starts.

* Your customized setting remains after turning the machine off and on.

Press  or  to select the length of jump stitch.

For example: Press  to select 25 mm (1 inch) and the machine will not trim a jump stitch of 25 mm or less before moving to the next stitching.

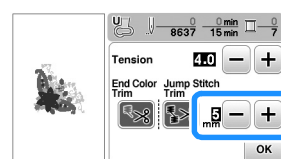

Memo

- If a design has many trims it is recommended to select a higher jump stitch trim setting in order to reduce the amount of excess tails on backside of fabric.
- The higher number of the jump stitch length selected, the fewer number of times the machine will trim. In this case, more jump stitches will remain on the surface of the fabric.

Embroidering the appliqué patterns

When the color embroidering order display shows [APPLIQUE MATERIAL], [APPLIQUE POSITION] or [APPLIQUE], follow the procedure below.

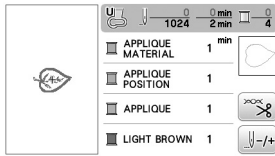

Required materials

- Fabric for the appliqué piece
- Fabric for the appliqué base
- Stabilizer material
- Fabric glue or temporary spray adhesive
- Embroidering thread

Note

- The correct names and numbers of the thread colors to be used will not appear. Select the thread colors depending on those in the appliqué pattern.

1. Creating an appliqué piece

- 1 Attach stabilizer material to the wrong side of the appliqué fabric.
- 2 Sew the cutting line of the appliqué piece. Remove the fabric for the appliqué piece from the embroidery frame, and then carefully cut along the sewn cutting line.

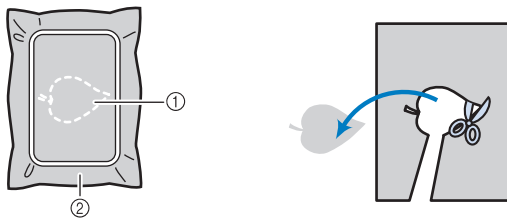

- ① Outline of appliqué
- ② Appliqué material

Note

- If the appliqué piece is cut out along the inside of the cutting line, it may not be correctly attached to the fabric. Therefore, carefully cut out the appliqué piece along the cutting line.
- After cutting out the appliqué piece, carefully remove any remaining thread.

2. Sewing the appliqué position on the base fabric

- 1 Sew the appliqué position.

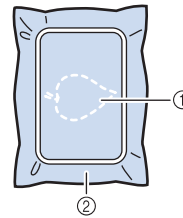

- ① Position of appliqué
- ② Base material

- 2 Remove the embroidery frame from the embroidery unit.

Note

- Do not remove the base fabric from the embroidery frame until all sewing is finished.

3. Affixing the appliqué piece to the base fabric

- 1 Lightly apply fabric glue or temporary spray adhesive to the back of the appliqué piece, and then attach it to the base fabric within the outline of the position sewn in step 1 of "2. Sewing the appliqué position on the base fabric".

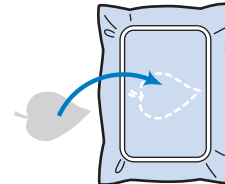

Note

- If the appliqué piece cannot be attached to the base fabric with fabric glue or temporary spray adhesive, securely baste it in place with basting stitches.
- If thin fabric is used for the appliqué piece, reinforce and secure it in place with an iron-on adhesive sheet. An iron can be used to attach the appliqué piece to the appliqué location.

- 2 After the appliqué piece is attached, attach the embroidery frame to the machine. Thread the machine with the embroidery thread, lower the presser foot lever, and then press the "Start/Stop" button to embroider the appliqué.

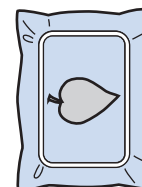

3 Finish embroidering the remainder of the pattern.

Using a frame pattern to make an appliqué

You can use frame patterns of the same size and shape to create an appliqué. Embroider one pattern with a straight stitch and one pattern with a satin stitch.

Method 1

- 1 Select a straight stitch frame pattern. Embroider the pattern onto the appliqué material, then cut neatly around the outside of the shape.

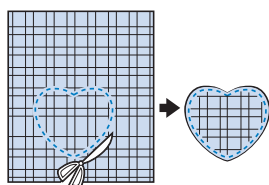
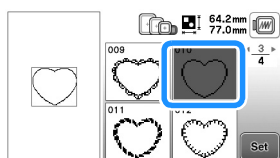

- 2 Embroider the same pattern from step 1 onto the base fabric. Apply a thin layer of fabric glue or a temporary spray adhesive to the back of the appliqué created in step 1. Attach the appliqué to the base fabric matching the shapes.

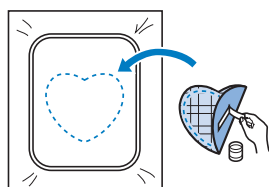

- 3 Select the satin stitch frame pattern of the same shape as the appliqué. Embroider over the appliqué and base fabric from step 2 to create the appliqué.

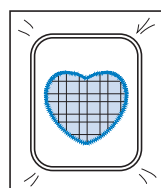
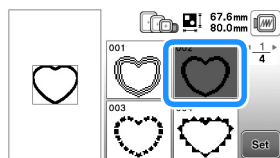

Method 2

- 1 Select a straight stitch frame pattern, and embroider the pattern onto the base fabric.

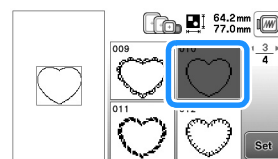

- 2 Place the appliqué fabric over the pattern embroidered in step 1 and embroider the same pattern on the appliqué fabric.

- Be sure that the appliqué fabric completely covers the stitched line.

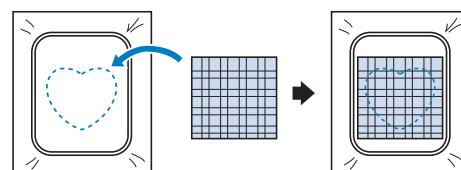

- 3 Remove the embroidery frame from the embroidery unit, and cut around the outside of the stitches of the appliqué fabric.

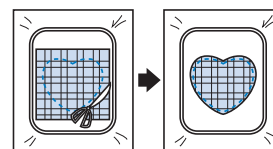

Note

- Do not remove the fabric from the embroidery frame to cut it. Also, do not pull or push on the fabric. Otherwise, the fabric may loosen in the frame.

- 4 Reattach the embroidery frame to the embroidery unit.

- 5 Select the satin stitch frame pattern of the same shape as the appliqué and embroider the satin stitch pattern to create an appliqué.

- Do not change the size or position of the pattern.

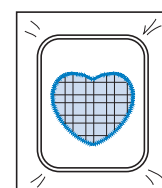
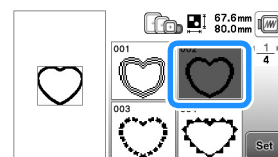

Split embroidery patterns

Split embroidery patterns created with PE-DESIGN Ver.7 or later, or PE-DESIGN NEXT can be embroidered. With split embroidery patterns, embroidery designs larger than the embroidery hoop are divided into multiple sections, which combine to create a single pattern after each section is embroidered.

For details on creating split embroidery patterns and for more detailed embroidery instructions, refer to the Instruction manual included with PE-DESIGN Ver.7 or later, or PE-DESIGN NEXT.

1 Insert the USB flash drive containing the created split embroidery pattern, and then select the split embroidery pattern to be embroidered.

- For details, refer to “Retrieving embroidery patterns” on page 102.

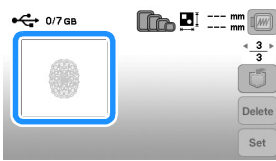

2 Select section **Aa** to be embroidered and press **Set**.



- Select the sections in alphabetical order.

3 Press **Edit End** and press **Embroidery**.

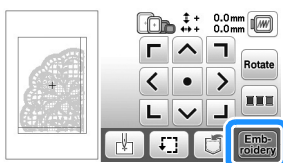

4 Press the “Start/Stop” button to embroider the pattern section.

5 When embroidering is finished, the following screen appears. Press **OK**.

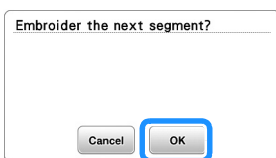

→ A screen appears so that a section of the split embroidery pattern can be selected.

6 Repeat steps **2** through **5** to embroider the remaining sections of the pattern.

Editing Patterns (Pattern Editing Screen)

When a pattern is selected in the pattern selection screen and **Set** is pressed, the pattern editing screen appears.

After pressing any of the keys to edit the pattern, press **OK** to return to the previous screen. To finish all the editing, press **Edit End** to continue to the embroidery settings screen.

CAUTION

- When you have revised the pattern, check the display of available embroidery frames and use an appropriate frame. If you use an embroidery frame not displayed as available for use, the presser foot may strike the frame and possibly cause injury or damage.

Pattern editing screen

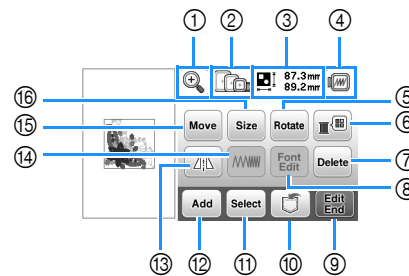

Memo

- If a key display is light gray, you cannot use that function with the selected pattern.

No.	Display Key Name	Explanation
①	Magnify key	Press this key to magnify the pattern in the screen.
②	Embroidery frame	Shows the embroidery frames that can be used (page 86).
③	61.6mm 76.9mm Pattern size	Shows the size of the entire combined pattern.
④	Preview key	Press this key to show embroidered image. Press to select the frame used in the preview. <ul style="list-style-type: none"> : Small embroidery frame (sold separately with some models)/2 cm × 6 cm (1 inch × 2-1/2 inches) : Medium embroidery frame (sold separately with some models)/10 cm × 10 cm (4 inches × 4 inches) : Large embroidery frame (sold separately with some models)/18 cm × 13 cm (7 inches × 5 inches) : Extra large embroidery frame/26 cm × 16 cm (10-1/4 inches × 6-1/4 inches) Press to enlarge the image of the pattern.

No.	Display	Explanation
	Key Name	
⑤		Press this key to rotate the pattern. Press to return the pattern to its original position.
	Rotate key	
⑥		Press this key to change the colors of the displayed pattern. Press or to select the thread brand. Press or to select the color you want to change. Press , , , or touch the color on the color palette to choose a new color. To return to the original color, press .
	Thread palette key	
⑦		Press this key to delete the selected pattern (the pattern outlined by the red box).
	Delete key	
⑧		Press this key to display the font editing screen. (page 97)
	Font edit key	
⑨		Press this key to call up the embroidery settings screen. (page 98)
	Edit End key	
⑩		Press this key to save patterns to the machine's memory or USB flash drive. Patterns can also be transferred to a computer via wireless network connection. (page 101)
	Memory key	
⑪		When a combined pattern is selected, use this key to select a part of the pattern to edit. The selected pattern is outlined by the red box.
	Pattern select key	
⑫		Press this key to add another embroidery pattern to currently displayed pattern.
	Add key	
⑬		Press this key to make a horizontal mirror image of the selected pattern.
	Horizontal mirror image key	
⑭		Press this key to change thread density for some alphabet character and frame patterns.
	Thread density key	
⑮		Press this key to move the pattern. Use to move the pattern in the direction shown by the arrow. Press to center the pattern.
	Move key	

No.	Display	Explanation
	Key Name	
⑯		Press this key to change the size of the pattern. : Enlarges the pattern proportionately. : Decreases the pattern proportionately. : Stretches the pattern horizontally. : Decreases the pattern horizontally. : Stretches the pattern vertically. : Decreases the pattern vertically. : Returns the pattern to its original size. : Changes the size of the character patterns.
	Size key	

■ Font editing screen

Font editing screen appears by pressing on the pattern editing screen.

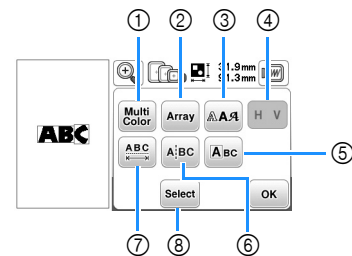

No.	Display	Explanation
	Key Name	
①		Press this key when you want to change the thread color, character by character in character embroidery. Since the machine stops at the end of each character, the upper thread is changed as you embroider. Press this key again to cancel setting.
	Multi color key	
②		Press this key to change the configuration of a character pattern. When selecting an arc (), use and to change the degree of the arc. : Make the arc flatter. : Make the arc rounder. When selecting , and change to and . You can increase or decrease the incline. Press to return the character patterns to its original appearance.
	Array key	
③		Press this key to change the font of the selected characters. Depending on the font that was selected, it may not be possible to change the font.
	Font key	
④		Press this key to switch between text written vertically and horizontally. (Japanese font only)
	Vertical/horizontal text key	

No.	Display	Explanation
	Key Name	
⑤		Press this key to edit each character separately.
	Edit character key	
		When pressing , select the character by using to change the size.
		When pressing , select the character by using to change the font.
⑥		Press this key to split text between characters so that they can be edited separately.
	Split text key	
		Use to select where the pattern is to be separated, and then press to separate it.
		Any pattern that is split cannot be recombined.
⑦		Press this key to change the spacing of character patterns.
	Character spacing key	
		Press to increase or decrease the character spacing.
		Press to return the pattern to its original appearance.
⑧		When a combined pattern is selected, use this key to select a part of the pattern to edit. The selected pattern is outlined by the red box. If the line feed key was used while entering text, single lines can be selected.
	Select key	

Editing Patterns (Embroidery Settings Screen)

When is pressed in the editing screen, the embroidery settings screen appears. After editing the pattern, press to continue to the embroidering screen.

■ Embroidery settings screen

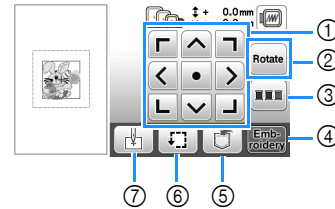

No.	Display	Explanation
	Key Name	
①		Press these keys to move the pattern in the direction shown by the arrow. (Press the center key to return the pattern to the center of the embroidery area.) (page 99)
	Move key	
②		Press this key to rotate the entire pattern. Press to return the pattern to its original position.
	Rotate key	
③		Press this key to rearrange the stitching sequence for combined patterns.
④		Press this key to enter the embroidery screen.
⑤		Press this key to save patterns to the machine's memory or USB flash drive. Patterns can also be transferred to a computer via wireless network connection. (page 101)
⑥		Press this key to check the position of the pattern. (page 88)
⑦		Press this key to move the needle start position to align the needle with the pattern position. (page 99)

Aligning the pattern and the needle position

Example: Aligning the lower left side of a pattern and the needle position

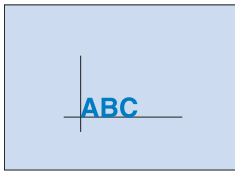

- 1 Mark the embroidery start position on the fabric, as shown.

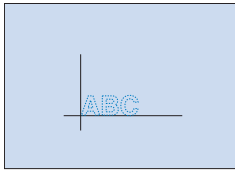

- 2 Press .

- 3 Press and press **OK**.

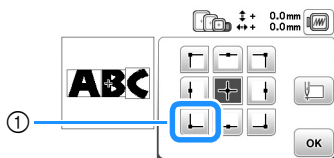

① Start position

→ The needle position moves to the bottom left corner of the pattern (the embroidery frame moves so that the needle is positioned correctly).

- 4 Use to align the needle and the mark on the fabric, press **Embroidery** and begin embroidering the pattern.

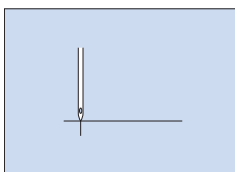
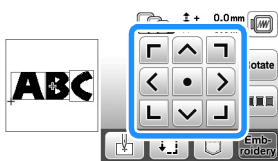

Embroidering linked characters

Follow the procedure described below to embroider linked characters in a single row when the entire pattern extends beyond the embroidery frame.

Example: Linking "DEF" to the characters "ABC" using embroidery frame 10 cm × 10 cm (4 inches × 4 inches) (sold separately with some models)

- 1 Select the character patterns for "ABC", and then press **Set** and **Edit End**.

- 2 Press .

- 3 Press , and then press **OK**.

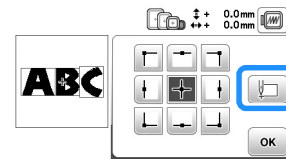

→ The needle is positioned in the lower-left corner of the pattern. The embroidery frame moves so that the needle is positioned correctly.

- 4 Press **Embroidery**.

- 5 Lower the embroidery foot and then press the "Start/Stop" button to begin embroidering.

- 6 After the characters are embroidered, and the threads are cut, remove the embroidery frame, and then press **OK** for [Finished embroidering].

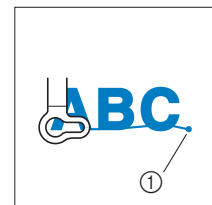

① End of the embroidering

- 7 Reposition the fabric in embroidery frame so that the right side of the letter "C" will be partially inside the embroidery frame; being careful so letters remain straight and level. Then reattach frame again so that the remaining characters ("DEF") can be embroidered.

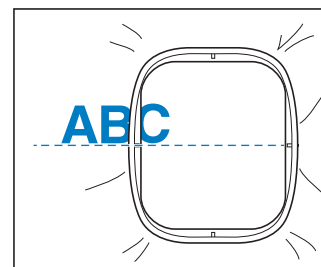

- 8 Press to cancel the current character patterns.
- 9 Select the character patterns for “DEF”, and then press and .
- 10 Press .
- 11 Press , and then press .
→ The needle is positioned in the lower-left corner of the pattern. The embroidery frame moves so that the needle is positioned correctly.
- 12 Use to align the needle with the end of the embroidering for the previous pattern.

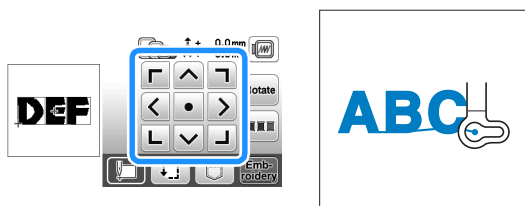

- 13 Press .
- 14 Lower the embroidery foot and press the “Start/Stop” button to begin embroidering the remaining character patterns.



Thread color sorting

This function allows you to embroider while replacing the thread spool a minimal number of times.

Before starting to embroider, press in the embroidery settings screen to rearrange the embroidery order and sort it by thread colors.

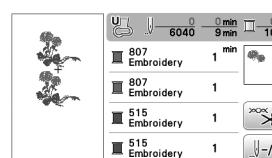
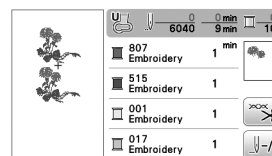

- 1 Press .
* Press again to check the sorted thread colors.

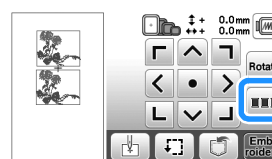

The embroidery color order is rearranged and sorted by thread colors.

Press again in the embroidery settings screen to cancel color sorting and embroider with the original embroidery color order.

Note

- This function does not work on overlapping designs.

Using the Memory Function

■ Embroidery data precautions

⚠ CAUTION

- When using embroidery data other than our original patterns, the thread or needle may break when embroidering with a stitch density that is too fine or when embroidering three or more overlapping stitches. In that case, use one of our original data design systems to edit the embroidery data.

□ Types of embroidery data that can be used

Only .pes, .phc, .pen, and .dst embroidery data files can be used with this machine. Attempting to use data other than the listed type may cause the machine to malfunction.

□ Embroidery pattern size

This machine is compatible with embroidery patterns up to a maximum of 26 cm × 16 cm (approx. 10-1/4 inches × 6-1/4 inches).

□ USB flash drive

Some USB flash drives may not be usable with this machine. Please visit our website " <http://s.brother/cpham/> " for more details.

□ Precautions on using the computer to create and save data

We recommend using the 26 letters of the alphabet (uppercase and lowercase), the numbers 0 through 9, "-", and "_" for the name of the file/folder.

□ Tajima (.dst) embroidery data

- .dst data is displayed in the pattern list screen by file name (the actual thumbnail image cannot be displayed).
- Since Tajima (.dst) data does not contain specific thread color information, it is displayed with our default thread color sequence. Check the preview and change the thread colors as desired.

Saving embroidery patterns

You can save embroidery patterns that you have customized in the machine's memory, or on a USB flash drive.

You can also transfer the patterns to your computer via wireless network.

💡 Note

- Do not turn the main power to OFF while the [Saving...] screen is displayed. You will lose the pattern you are saving.

- 1 Press  when the pattern you want to save is in the pattern editing screen or embroidery settings screen.

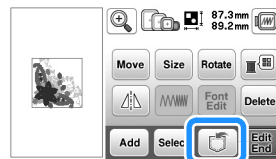

- 2 When saving the embroidery pattern in a USB flash drive, insert the USB flash drive into the USB port on the machine.

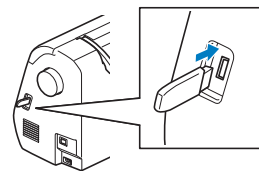

- 3 Select the destination to start saving.

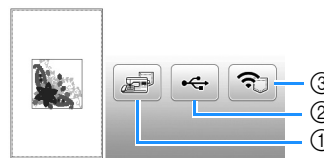

- ① Save to the machine's memory.
- ② Save to the USB flash drive.
The pattern is saved in a folder labeled "bPocket".
- ③ Temporarily save to the wireless function pocket.
For the detailed procedure, refer to the manual for PE-DESIGN (version 11 or later).
 - * Embroidery patterns which were saved to the wireless function pocket will be deleted from the pocket when turning the machine off. Import the embroidery patterns to PE-DESIGN (version 11 or later) before turning the machine off.

Retrieving embroidery patterns

Retrieve embroidery patterns saved in the machine's memory, or on a USB flash drive, or transferred via wireless network.

- 1 When retrieving the embroidery patterns from a USB flash drive, insert the USB flash drive into the USB port on the machine.

To retrieve embroidery patterns via wireless network, use PE-DESIGN (version 11 or later) or Design Database Transfer to transfer the patterns in advance. For details on transferring embroidery patterns, refer to the manual for PE-DESIGN or Design Database Transfer.

- 2 Press .

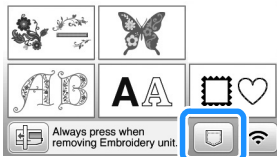

- 3 Press the desired destination, and then select the desired embroidery pattern.



- 1 Retrieve from the machine's memory.
 - 2 Retrieve from a USB flash drive.
 - 3 Retrieve embroidery patterns uploaded to the wireless function pocket via wireless network.
- For the detailed procedure, refer to the manual for PE-DESIGN (version 11 or later) or Design Database Transfer.

* Embroidery patterns which were uploaded via wireless network will be deleted from the machine when turning the machine off. Save patterns to the machine memory if necessary. (page 101)

Memo

- If the embroidery pattern to be retrieved is in a folder of the USB flash drive, press the key for that folder. Press  to return to the previous screen.

- 4 Press .



Memo

- When you press , the selected embroidery pattern will be deleted permanently.
- When saving a retrieved pattern, press the following keys.

1. Press .



2. Press the key for the desired destination.

 : Saves to the machine.

 : Saves to the USB flash drive.

 : Temporarily saves to the wireless function pocket.

When saving patterns retrieved via USB or wireless network to the machine, press .

Chapter 5 APPENDIX

Care and Maintenance

⚠ CAUTION

- Unplug the power cord before cleaning the machine, otherwise injuries or an electric shock may occur.

Cleaning the LCD

If the surface of the LCD is dirty, lightly wipe it with a soft dry cloth.

Cleaning the machine surface

When wiping dirt off the machine, firmly wring a soft cloth soaked in (lukewarm) water.

After cleaning the machine, dry it with a soft, dry cloth.

Restrictions on oiling

In order to prevent damaging this machine, it must not be oiled by the user.

This machine was manufactured with the necessary amount of oil applied to ensure correct operation, making periodic oiling unnecessary.

If problems occur, such as difficulty turning the handwheel or an unusual noise, immediately stop using the machine, and contact your authorized Brother dealer or the nearest Brother authorized service center.

Precautions on storing the machine

Do not store the machine in any of the locations described below, otherwise damage to the machine may result, for example, rust caused by condensation.

- Exposed to extremely high temperatures
- Exposed to extremely low temperatures
- Exposed to extreme temperature changes
- Exposed to high humidity or steam
- Near a flame, heater or air conditioner
- Outdoors or exposed to direct sunlight
- Exposed to extremely dusty or oily environments

💡 Note

- In order to extend the life of this machine, periodically turn it on and use it. Storing this machine for an extended period of time without using it may reduce its efficiency.

Cleaning the race

Stitching performance will suffer if lint and dust collects in the bobbin case, therefore, it should be cleaned regularly.

- 1 Press  (Needle position button) to raise the needle.
- 2 Turn off the machine.
- 3 Unplug the power cord from the power supply jack on the right side of the machine.
- 4 Raise the presser foot to remove the needle and presser foot.
 - For details, refer to “Replacing the Needle” on page 28 and “Replacing the Presser Foot” on page 29.
- 5 Remove the flat bed attachment or the embroidery unit if either is attached.
- 6 Remove the bobbin cover.
- 7 Remove the needle plate cover.

■ If there is a screw in the needle plate cover

- 1 Use the L-shaped (or disc-shaped) screwdriver to remove the screw in the needle plate cover.

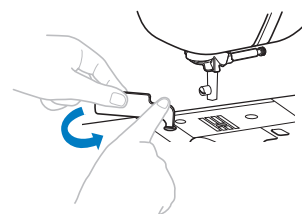

- 2 Grasp both sides of the needle plate cover, and then slide it toward you.

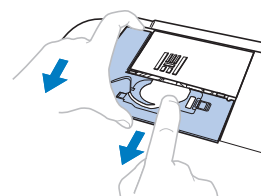

■ If there is no screw in the needle plate cover

- 1 Grasp both sides of the needle plate cover, and then slide it toward you.

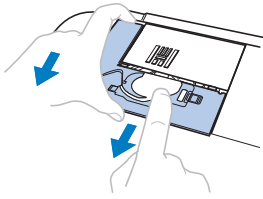

- 8 Grasp the bobbin case, and then pull it out.

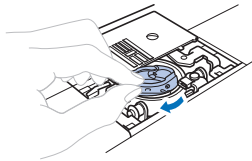

- 9 Use the cleaning brush or a vacuum cleaner to remove any lint and dust from the race and bobbin thread sensor and the surrounding area.

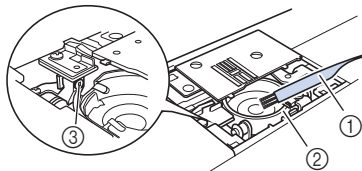

- ① Cleaning brush
- ② Race
- ③ Bobbin thread sensor

Note

- Do not apply oil to the bobbin case.

- 10 Insert the bobbin case so that the ▲ mark on the bobbin case aligns with the ● mark on the machine.

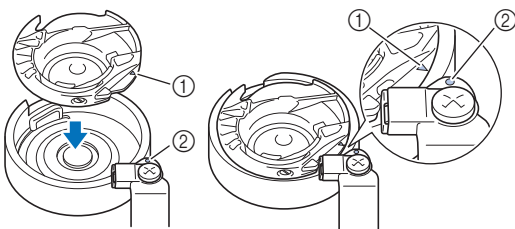

- Align the ▲ and ● marks.

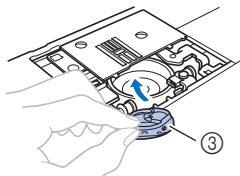

- ① ▲ mark
- ② ● mark
- ③ Bobbin case

- Make sure that the indicated points are aligned before installing the bobbin case.

- 11 Insert the tabs on the needle plate cover into the needle plate, and then slide the cover back on. Reattach the bobbin cover.

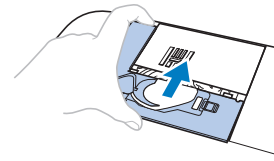

⚠ CAUTION

- Never use a bobbin case that is scratched or has a burr on it. Otherwise the upper thread may become tangled, the needle may break or sewing performance may suffer. For a new bobbin case, contact your nearest Brother authorized service center.
- Be sure that the bobbin case is correctly installed, otherwise the needle may break.

Touch panel is malfunctioning

If the screen does not respond correctly when you touch a key (the machine does not perform the operation or performs a different operation), follow the steps below to make the proper adjustments.

- 1 Holding your finger on the screen, turn the main power switch to OFF and back to ON.



→ The touch panel adjustment screen is displayed.

- 2 Lightly touch the center of each +, in order from 1 to 5.



- 3 Turn the main power to OFF, then turn it back to ON.

Troubleshooting

If the machine stops operating correctly, check the following possible problems before requesting service. You can solve most problems by yourself. If you need additional help, Brother support website offers the latest FAQs and troubleshooting tips. Visit us at “ <http://s.brother/cpham/> ”.

If the problem persists, contact your Brother dealer or the nearest Brother authorized service center.

■ Frequent troubleshooting topics

Detailed causes and remedies for common troubleshooting topics are described below. Be sure to refer to this before contacting us.

Upper thread tightened up	page 105
Tangled thread on wrong side of fabric	page 105
Incorrect thread tension	page 106
Fabric is caught in the machine and cannot be removed	page 106
If the thread becomes tangled under the bobbin winder seat	page 108

Upper thread tightened up

■ Symptom

- The upper thread appears as a single continuous line.
- The bobbin thread is visible from the right side of the fabric. (Refer to the illustration below.)
- The upper thread has tightened up, and comes out when pulled.
- The upper thread has tightened up, and wrinkles appear in the fabric.
- The upper thread tension is tight, and the results do not change even after the thread tension is adjusted.

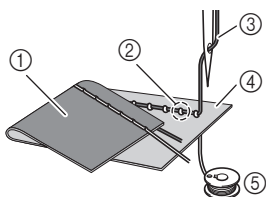

- ① Wrong side of fabric
- ② Bobbin thread visible from right side of fabric
- ③ Upper thread
- ④ Right side of fabric
- ⑤ Bobbin thread

■ Cause

Incorrect bobbin threading

If the bobbin thread is incorrectly threaded, instead of the appropriate tension being applied to the bobbin thread, it is pulled through the fabric when the upper thread is pulled up. For this reason, the thread is visible from the right side of the fabric.

■ Remedy/check details

Correctly install the bobbin thread. (page 22)

Tangled thread on wrong side of fabric

■ Symptom

- The thread becomes tangled on the wrong side of the fabric.

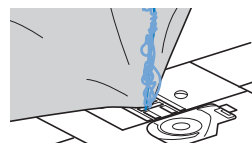

- After starting sewing, a rattling noise is made and sewing cannot continue.
- Looking under the fabric, there is tangled thread in the bobbin case.

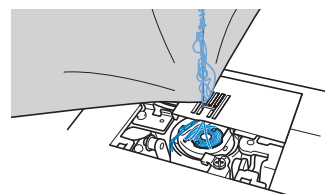

■ Cause

Incorrect upper threading

If the upper thread is incorrectly threaded, the upper thread passing through the fabric cannot be firmly pulled up and the upper thread becomes tangled in the bobbin case, causing a rattling noise.

■ Remedy/check details

Remove the tangled thread, and then correct the upper threading.

- 1 Remove the tangled thread. If it cannot be removed, cut the thread with scissors.
 - For details, refer to “Cleaning the race” on page 103.
- 2 Remove the upper thread from the machine.
- 3 Correct the upper threading by following the instructions in “Threading the upper thread” on page 24.
 - If the bobbin was removed from the bobbin case, refer to “Installing the bobbin” on page 22 to correctly install the bobbin.

Incorrect thread tension

Symptoms

- Symptom 1: The bobbin thread is visible from the right side of the fabric. (Refer to illustration below)
- Symptom 2: The upper thread appears as a straight line on the right side of the fabric.
- Symptom 3: The upper thread is visible from the wrong side of the fabric. (Refer to illustration below)
- Symptom 4: The bobbin thread appears as a straight line on the wrong side of the fabric.
- Symptom 5: The stitching on the wrong side of the fabric is loose or has slack.

Symptom 1

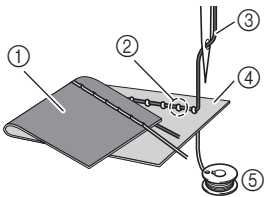

- ① Wrong side of fabric
- ② Bobbin thread visible from right side of fabric
- ③ Upper thread
- ④ Right side of fabric
- ⑤ Bobbin thread
- ⑥ Upper thread visible from wrong side of fabric

Symptom 3

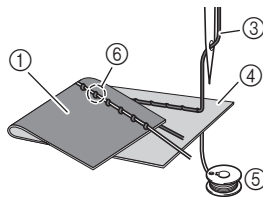

Cause/remedy/check details

Cause 1

The machine is not correctly threaded.

<With symptoms 1 and 2 described above>

The bobbin threading is incorrect.

Return the upper thread tension to the standard setting, and then refer to "Installing the bobbin" on page 22 to correct the threading.

<With symptoms 3 and 5 described above>

The upper threading is incorrect.

Return the upper thread tension to the standard setting, and then refer to "Threading the upper thread" on page 24 to correct the upper threading.

Cause 2

A needle and thread appropriate for the fabric are not being used.

The machine needle that should be used depends on the type of fabric sewn and the thread thickness.

If a needle and thread appropriate for the fabric are not being used, the thread tension will not be correct, causing wrinkles in the fabric or skipped stitches.

- Refer to "Fabric/Thread/Needle Combinations" on page 27 to check that a needle and thread appropriate for the fabric are being used.

Cause 3

An appropriate upper tension is not selected.

Select an appropriate thread tension.

Refer to "Adjusting the Thread Tension" on page 38.

The appropriate thread tension differs depending on the type of fabric and thread being used.

- * Adjust the thread tension while test sewing on a piece of scrap fabric that is the same as that used in your project.

Note

- If the upper threading and bobbin threading are incorrect, the thread tension cannot be adjusted correctly. Check the upper threading and bobbin threading first, and then adjust the thread tension.

- **If the bobbin thread is visible from the right side of the fabric**

Press **-** in the manual adjustment screen to decrease the tension of the upper thread.

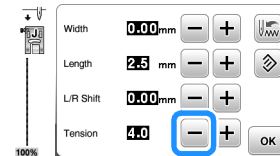

- **If the upper thread is visible from the wrong side of the fabric**

Press **+** in the manual adjustment screen to increase the tension of the upper thread.

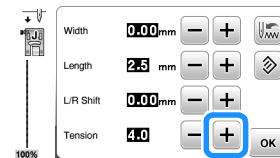

Fabric is caught in the machine and cannot be removed

If the fabric is caught in the machine and cannot be removed, the thread may have become tangled under the needle plate. Follow the procedure described below to remove the fabric from the machine. If the operation cannot be completed according to this procedure, instead of attempting to remove it forcefully, contact your nearest Brother authorized service center.

Removing the fabric from the machine

1 Immediately stop the machine.

2 Turn off the machine.

3 Remove the needle.

If the needle is lowered into the fabric, turn the handwheel away from you (clockwise) to raise the needle out of the fabric, and then remove the needle.

- Refer to "Replacing the Needle" on page 28.

4 Remove the presser foot and presser foot holder.

If the thread is entangled on the presser foot, remove the entangled thread, and then raise the presser foot lever to remove the presser foot. Otherwise, the presser foot may be damaged.

- Refer to "Replacing the Presser Foot" on page 29.

5 Lift up the fabric and cut the threads below it.
If the fabric can be removed, remove it. Continue with the following steps to clean the race.

6 Remove the needle plate cover.
• Refer to “Cleaning the race” on page 103.

7 Cut out the tangled threads, and then remove the bobbin.

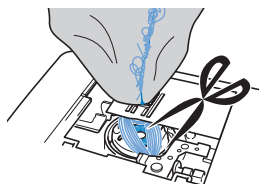

8 Remove the bobbin case.
If threads remain in the bobbin case, remove them.

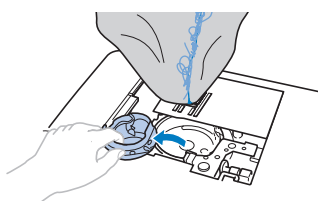

9 Use the cleaning brush or a vacuum cleaner mini attachment to remove any lint or dust from the race and its surrounding area.

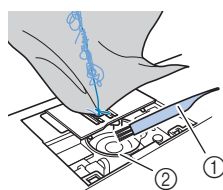

- ① Cleaning brush
- ② Race

If the fabric could be removed.	Continue with step 16 .
If the fabric could not be removed.	Continue with step 10 .

Note

- Compressed can air is not recommended to be used.

10 Use the included disc-shaped screwdriver to loosen the two screws on the needle plate.

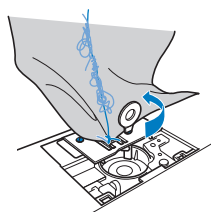

Note

- Be careful not to drop the removed screws in the machine.

11 Slightly lift up the needle plate, cut any tangled threads, and then remove the needle plate.
Remove the fabric and threads from the needle plate.

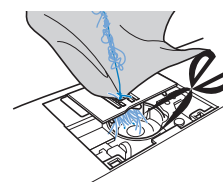

If the fabric cannot be removed, even after completing these steps, contact your nearest Brother authorized service center.

12 Remove any threads in the race and around the feed dogs.

13 Turn the handwheel to raise the feed dogs.

14 Align the two screw holes in the needle plate with the two holes at the needle plate mounting base, and then fit the needle plate onto the machine.

15 Lightly finger-tighten the screw on the right side of the needle plate. Then, use the disc-shaped screwdriver to firmly tighten the screw on the left side. Finally, firmly tighten the screw on the right side.

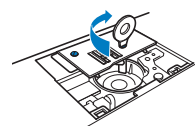

Turn the handwheel to check that the feed dogs move smoothly and do not contact the edges of the slots in the needle plate.

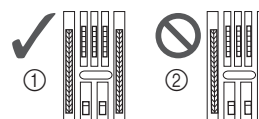

- ① Correct position of feed dogs
- ② Incorrect position of feed dogs

16 Insert the bobbin case by following step 10 in “Cleaning the race” on page 103.

17 Attach the needle plate cover according to step 11 in “Cleaning the race” on page 103.

18 Check the condition of the needle, and then install it.
If the needle is in a poor condition, for example, if it is bent, be sure to install a new needle.

- Refer to “Checking the needle” on page 28 and “Replacing the needle” on page 28.

Memo

- Since the needle may have been damaged when the fabric was caught in the machine, we recommend replacing it with a new one.

■ Checking machine operations

If the needle plate has been removed, check machine operations to confirm that installation has been completed correctly.

1 Turn on the machine.

2 Select stitch .

Note

- Do not yet install the presser foot and thread.

3 Slowly turn the handwheel toward you (counterclockwise), and look from all sides to check that the needle falls at the center of the opening in the needle plate.

If the needle contacts the needle plate, remove the needle plate, and then install it again, starting with step 13 in “Removing the fabric from the machine” on page 106.

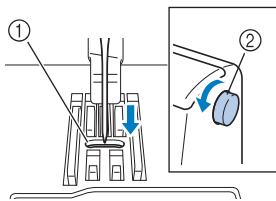

- ① Opening in the needle plate
- ② Handwheel

4 Select stitch . At this time, increase the stitch length and width to their maximum settings.

- For details on changing the settings, refer to “Setting the stitch width” on page 38 and “Setting the stitch length” on page 38.

5 Slowly turn the handwheel toward you (counterclockwise) and check that the needle bar and feed dogs operate correctly.

If the needle or feed dogs make contact the needle plate, the machine may be malfunctioning; therefore, contact your nearest Brother authorized service center.

6 Turn off the machine, and then install the bobbin and presser foot.

Never use a scratched or damaged presser foot. Otherwise, the needle may break, or sewing performance may suffer.

- Refer to “Installing the bobbin” on page 22 and “Replacing the presser foot” on page 29.

7 Correctly thread the machine.

- For details on threading the machine, refer to “Upper Threading” on page 24.

8 Perform trial sewing with cotton fabric.

Note

- Incorrect sewing may be the result of incorrect upper threading or sewing thin fabrics. If there are poor results from the trial sewing, check the upper threading or the type of fabric being used.

If the thread becomes tangled under the bobbin winder seat

If the bobbin winding starts when the thread is not passed under the pretension disk of the bobbin winding thread guide correctly, the thread may become tangled under the bobbin winder seat.

CAUTION

- Do not remove the bobbin winder seat even if the thread become tangled under the bobbin winder seat. Otherwise, the cutter in the bobbin winder seat may be damaged.
- Do not remove the screw on the bobbin winder guide post, otherwise the machine may be damaged; you cannot wind off the thread by removing the screw.

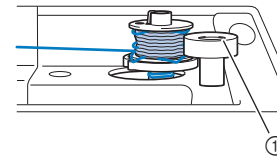

- ① Screw of the bobbin winder guide post

1 Stop the bobbin winding.

2 Cut the thread with scissors beside the bobbin winding thread guide.

3 Slide the bobbin winder shaft to the left, and then remove the bobbin from the shaft and cut the thread leading to the bobbin in order to be able to completely remove the bobbin from shaft.

4 Hold the thread end with your left hand, and wind off the thread clockwise from under the bobbin winder seat with your right hand as shown below.

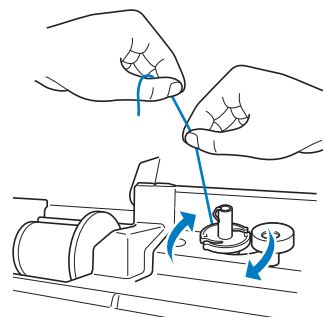

List of symptoms

Check the following possible problems before requesting service. If the reference page is “*”, contact your authorized Brother dealer or the nearest Brother authorized service center.

■ Getting ready

Symptom, Cause/solution	Reference
Cannot thread the needle.	
Needle is not in the correct position. • Press the “Needle position” button to raise the needle.	10
Needle is installed incorrectly.	28
Needle is turned, bent or the point is dull.	28
Upper threading is incorrect. The needle threader lever is not lowered until it clicks.	24
The needle threader hook is bent and does not pass through the eye of the needle.	*
The needle threader lever cannot be moved or returned to its original position.	*
A size 65/9 needle is being used. • The needle is incompatible with the needle threader. Manually pass the thread through the eye of the needle.	25
Cannot lower the presser foot with the presser foot lever.	
Presser foot was raised using the “Presser foot lifter” button.	10
Bobbin thread does not wind neatly on the bobbin.	
The thread is not passed through the bobbin winding thread guide correctly.	20
The thread that was pulled out from the bobbin winding thread guide was incorrectly wound onto the bobbin.	21
The empty bobbin was not set on the pin properly.	20
While winding the bobbin, the bobbin thread was wound below the bobbin winder seat.	
The thread was incorrectly passed under the pretension disk on the bobbin winding thread guide. • Remove any entangled thread, and then wind the bobbin.	20, 108
The bobbin thread cannot be pulled up.	
Needle is turned, bent or the point is dull.	28
Bobbin is set incorrectly.	22
Nothing appears in the LCD.	
Main power switch is not turned on.	12
The plug of the power cord is not inserted into an electrical outlet.	12
The LCD screen is fogged up.	
Condensation has formed on the LCD screen. • After a while, the cloudiness will disappear.	–

Symptom, Cause/solution	Reference
The operation keys do not respond, or the key response is too sensitive.	
A glove is worn when the keys are pressed. The keys are pressed with a fingernail. A non-electrostatic touch pen is being used. The sensitivity of the operation keys is not set for the user.	13, 17
The sewing light does not come on.	
[Light] is set to [OFF] in the settings screen.	16
Embroidery unit does not operate.	
Embroidery unit is not attached correctly.	80
Embroidery frame was attached before the unit was initialized.	80
Cannot retrieve an embroidery pattern via wireless network.	
Embroidery patterns unavailable for this machine cannot be retrieved. • Check the embroidery data and the message displayed on the application.	–

■ While sewing

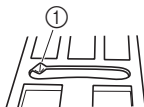
Symptom, Cause/solution	Reference
Machine does not operate.	
“Start/Stop” button was not pressed.	31
The bobbin winder shaft is pushed to the right.	20
There is no stitch selected.	31
Presser foot is not lowered.	32
“Start/Stop” button was pressed with the foot controller attached.	32
The “Start/Stop” button was pressed while the machine is set for the sewing speed controller to control the zigzag stitch width.	15, 66
Needle breaks.	
Needle is installed incorrectly.	28
Needle clamp screw is not tightened.	28
Needle is turned or bent.	28
Using improper needle or thread for the selected fabric.	27
Wrong presser foot was used.	29
Upper thread tension is too tight.	38
Fabric is pulled during sewing.	–
Spool of thread is set incorrectly.	20
There are scratches around the opening in the needle plate. * There is a notch on the left side of the opening in the needle plate. This is not a scratch.	*
	
There are scratches around the opening in the presser foot.	*
There are scratches on the bobbin case.	*

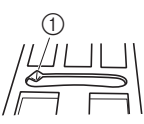
Symptom, Cause/solution	Reference
A bobbin designed specifically for this machine is not used.	20
Upper threading is incorrect.	24
Bobbin is set incorrectly.	22
Presser foot is attached incorrectly.	29
Screw of the presser foot holder is loose.	30
Fabric is too thick.	27, 41
Fabric is fed forcefully when sewing thick fabric or thick seams.	41
Stitch length is too short.	38
Stabilizer is not attached to fabric being embroidered.	82
Bobbin thread is incorrectly wound.	20
Upper thread breaks.	
Machine is not threaded correctly (used the wrong spool cap, spool cap is loose, the thread did not catch the needle bar threader, etc.).	24
Knotted or tangled thread is being used.	–
The selected needle is not appropriate for the thread being used.	27
Upper thread tension is too tight.	38
Thread is tangled.	105
Needle is turned, bent or the point is dull.	28
Needle is installed incorrectly.	28
There are scratches around the opening of the needle plate.	*
* There is a notch on the left side of the opening in the needle plate. This is not a scratch.	
 ① Notch	
There are scratches around the opening in the presser foot.	*
There are scratches on the bobbin case.	*
Using improper needle or thread for the selected fabric.	27
A bobbin designed specifically for this machine is not being used.	20
The thread is tangled on the wrong side of the fabric.	
Upper threading is incorrect.	24, 105
Using improper needle or thread for the selected fabric.	27
The upper thread is too tight.	
The bobbin thread is incorrectly installed.	22
Bobbin thread breaks.	
Bobbin is set incorrectly.	22
Bobbin thread is incorrectly wound.	20
A scratched bobbin is being used.	22
Thread is tangled.	106
A bobbin designed specifically for this machine is not being used.	20

Symptom, Cause/solution	Reference
Fabric puckers.	
There is a mistake in the upper or bobbin threading.	20, 24
Spool of thread is set incorrectly.	20
Using improper needle or thread for the selected fabric.	27
Needle is turned, bent or the point is dull.	28
Stitches are too long when sewing thin fabrics.	38
Thread tension is set incorrectly.	38, 106
Wrong presser foot was used. <ul style="list-style-type: none"> Fabric was not stabilized correctly. 	29
The stitch is not sewn correctly.	
The presser foot that is used is not appropriate for the type of stitch that you wish to sew.	29
The thread tension is incorrect.	38, 106
The thread is tangled, for example, in the bobbin case.	106
Feed dogs are set in the down position. <ul style="list-style-type: none"> Slide the feed dog position switch to the right (▲▲). 	9, 65
Skipped stitches	
Machine is threaded incorrectly.	20, 24
Using improper needle or thread for the selected fabric.	27
Needle is turned, bent or the point is dull.	28
Needle is installed incorrectly.	28
Dust or lint has collected under the needle plate.	103
Thin or stretch fabrics are being sewn. <ul style="list-style-type: none"> Attach stabilizer material to the fabric. 	42
Not stitching	
Needle is turned, bent or the point is dull.	28
Bobbin is set incorrectly.	22
Upper threading is incorrect.	24
High-pitched sound while sewing	
Dust or lint is caught in the feed dogs.	103
Pieces of thread are caught in the race.	103
Upper threading is incorrect.	24
A bobbin designed specifically for this machine is not being used.	20
There are needle holes or friction scratches in the bobbin case.	*
Fabric does not feed through the machine.	
Feed dogs are set in the down position. <ul style="list-style-type: none"> Slide the feed dog position switch to the right (▲▲). 	9
Stitches are too close together.	38
Wrong presser foot was used.	29
Needle is turned, bent or the point is dull.	28
Thread is entangled.	106
Zigzag foot “J” is slanted on a thick seam at the beginning of stitching.	41
Presser foot pressure is set incorrectly for fabric.	15

Symptom, Cause/solution	Reference
The fabric feeds in the opposite direction.	
The feed mechanism is damaged.	*
The needle contacts the needle plate.	
The needle clamp screw is loose.	28
Needle is turned, bent or the point is dull.	28
Fabric being sewn with the machine cannot be removed.	
Thread is tangled below the needle plate.	106
A broken needle has fallen into the machine.	
<ul style="list-style-type: none"> Turn off the machine, and remove the needle plate. If the needle that fell into the machine can be seen, use tweezers to remove it. After removing the needle, return the needle plate to its original position and insert a new needle. Before turning on the machine, slowly turn the handwheel toward you to check that it turns smoothly and that the new needle enters through the center of the needle plate opening. If the handwheel does not turn smoothly or the needle that fell into the machine cannot be removed, consult your authorized Brother dealer or the nearest Brother authorized service center. 	106
The handwheel does not turn smoothly.	
Thread is tangled in the bobbin case.	103, 105, 106

■ After sewing



Symptom, Cause/solution	Reference
Thread tension is incorrect.	
Upper threading is incorrect.	24, 106
Bobbin is set incorrectly.	22, 106
Using improper needle or thread for the selected fabric.	27
Presser foot holder is not attached correctly.	30
Thread tension is set incorrectly.	38, 106
Bobbin thread is incorrectly wound.	20
Needle is turned, bent or the point is dull.	28
A bobbin designed specifically for this machine is not used.	20
Character or decorative stitch patterns are misaligned.	
Wrong presser foot was used.	29
Stitch pattern adjustment settings were set incorrectly.	73
Stitch pattern is irregular.	
Wrong presser foot was used.	29
Thin or stretch fabrics are being sewn. <ul style="list-style-type: none"> Attach stabilizer material to the fabric. 	42
Thread tension is set incorrectly.	38, 106
Fabric was pulled, pushed or fed at an angle while it was being sewn. <ul style="list-style-type: none"> Sew while guiding the fabric with your hands so that the fabric is fed in a straight line. 	31
The thread is tangled, for example, in the bobbin case.	103

Symptom, Cause/solution	Reference
Embroidery pattern does not embroider correctly.	
Thread is twisted.	106
Thread tension is set incorrectly.	38, 106
Fabric was not inserted into the frame correctly (fabric was loose, etc.).	83
Stabilizing material was not attached. <ul style="list-style-type: none"> Always use stabilizing material, especially with stretch fabrics, lightweight fabrics, fabrics with a coarse weave, or fabrics that often cause pattern shrinkage. See your authorized Brother dealer for the proper stabilizer. 	82
There was an object placed near the machine, and the carriage or embroidery frame hit the object during embroidering.	79
Material coming out of the embroidery frame is causing problems. <ul style="list-style-type: none"> Stretch the fabric on the frame once again so that the material coming out of the embroidery frame does not cause problems, rotate the pattern and embroider. 	82
A heavy fabric is being embroidered, and the fabric is hanging off the table. <ul style="list-style-type: none"> If embroidery is done with the fabric hanging off the table, the embroidery unit movement will be impaired. Support the fabric while embroidering. 	89
Fabric is snagged or caught on something. <ul style="list-style-type: none"> Stop the machine and place the fabric so that it does not get caught or snagged. 	–
The carriage was moved while the embroidery frame was being removed or attached during embroidery. <ul style="list-style-type: none"> If the carriage is moved during the process, the pattern may be misaligned. Be careful when removing or attaching the embroidery frame. 	84
Stabilizer is incorrectly attached, for example, it is smaller than the embroidery frame.	82
Embroidery pattern does not embroider in a particular position.	
Fabric isn't positioned with the proper position in the embroidery frame. <ul style="list-style-type: none"> Use the embroidery sheet. 	83
Loops appear on the surface of the fabric when embroidering.	
The thread tension is incorrectly set.	91
Embroidery bobbin thread intended for use with this machine is not being used.	81

Error messages

When erroneous operations are performed messages and advice on operation will be displayed on the LCD. Follow what is displayed. If you press or do the operation correctly while the error message is displayed, the message disappears.

	Error messages	Cause/solution
1	A malfunction occurred. Turn the machine off, then on again.	This message is displayed if a malfunction occurs. Turn the machine off, then back on again. If this message continues to appear, please contact your authorized Brother dealer or the nearest Brother authorized service center.
2	Cannot change the configuration of the characters.	This message is displayed when there are too many characters and the curved character configuration is impossible.
3	Cannot change the font since some letters are not included to the selected font.	This message appears when the font of the embroidery character pattern is changed to one that does not include characters used in the pattern.
4	Cannot recognize the data for the selected pattern. The data may be corrupted. Please turn off the power and turn on again.	This message appears when you try to retrieve pattern data that is invalid. Since any of the following may be the cause, check the pattern data. <ul style="list-style-type: none"> • The pattern data is damaged. • The data that you tried to retrieve was created using another manufacturer's data design system. Turn the machine off, then on again to return it to its normal condition.
5	Check and rethread the upper thread.	This message is displayed when the upper thread is broken or not threaded correctly, and the "Start/Stop" button, etc. is pressed.
6	Data volume is too large for this pattern.	This message is displayed when the patterns you are editing take up too much memory, or if you are editing too many patterns for the memory.
7	Lower the buttonhole lever.	This message is displayed when the buttonhole lever is up, a buttonhole stitch is selected, and the "Start/Stop" button, etc. is pressed.
8	Lower the presser foot lever.	This message is displayed when a button, such as the "Start/Stop" button, was pressed while the presser foot was raised.
9	No more patterns can be added to this combination.	This message is displayed when you tried to combine more than 70 decorative stitches.
10	Not enough available memory to save.	This message is displayed when the memory is full and the stitch or pattern cannot be saved.
11	Not enough available memory to save the pattern. Delete another pattern?	This message is displayed when the memory is full and the stitch or pattern cannot be saved. Press <input type="button" value="OK"/> and delete a previously saved stitch or pattern to save the current one. Press <input type="button" value="Cancel"/> to return to the original screen without saving.
12	OK to recall and resume previous memory?	This message appears if the machine is turned off while embroidering, then turned on again. Press <input type="button" value="OK"/> to return the machine to the condition (pattern position and number of stitches) when it was turned off. Follow the procedure described in "If the thread breaks during sewing" on page 91 to align the needle position and embroider the remainder of the pattern.
13	Pattern extends to the outside of embroidery frame.	This message appears when the selected embroidery pattern is larger than the embroidery frame selected when [Embroidery Frame Identification View] is set to [ON].
14	Pattern extends to the outside of embroidery frame. Add no additional characters.	This message is displayed when the character pattern combination is too large to fit in the embroidery frame. Change the character pattern size or layout the patterns to fit the embroidery frame. If [Embroidery Frame Identification View] is set to [ON], setting to [OFF] or selecting larger frame may help.
15	Pattern extends to the outside of embroidery frame. This function cannot be used at this time.	This message appears when the embroidery character pattern is resized or switched between written vertically/horizontally so that it is too large for the embroidery frame.
16	Preventive maintenance is recommended.	Once this message appears, it is recommended to take your machine to an authorized Brother dealer or nearest Brother authorized service center for a regular maintenance check. Although this message will disappear and the machine will continue to function once you press <input type="button" value="OK"/> , the message will display several more times until the appropriate maintenance is performed.

	Error messages	Cause/solution													
17	Raise the buttonhole lever.	This message is displayed when the buttonhole lever is down, a stitch other than a buttonhole is selected, and the "Start/Stop" button, etc. is pressed.													
18	The authentication and encryption methods used by the selected wireless LAN access point/router are not supported by your machine.	<p>The authentication/encryption methods used by the selected wireless access point/router are not supported by your machine.</p> <p>For infrastructure mode, change the authentication and encryption methods of the wireless access point/router. Your machine supports the following authentication methods:</p> <table border="1" data-bbox="767 443 1442 698"> <thead> <tr> <th>Authentication method</th> <th>Encryption method</th> </tr> </thead> <tbody> <tr> <td rowspan="2">WPA-Personal</td> <td>TKIP</td> </tr> <tr> <td>AES</td> </tr> <tr> <td rowspan="2">WPA2-Personal</td> <td>TKIP</td> </tr> <tr> <td>AES</td> </tr> <tr> <td rowspan="2">Open</td> <td>WEP</td> </tr> <tr> <td>None (without encryption)</td> </tr> <tr> <td>Shared key</td> <td>WEP</td> </tr> </tbody> </table> <p>If your problem is not solved, the SSID or network settings you entered may be incorrect. Reconfirm the wireless network settings. (page 18) Refer to "How can I find the wireless security information (SSID and network key)" on page 115.</p>	Authentication method	Encryption method	WPA-Personal	TKIP	AES	WPA2-Personal	TKIP	AES	Open	WEP	None (without encryption)	Shared key	WEP
Authentication method	Encryption method														
WPA-Personal	TKIP														
	AES														
WPA2-Personal	TKIP														
	AES														
Open	WEP														
	None (without encryption)														
Shared key	WEP														
19	The bobbin thread is almost empty.	<p>This message is displayed when the bobbin thread is running out. Although a few stitches can be sewn when the "Start/Stop" button is pressed, replace with a wound bobbin immediately.</p> <p>When embroidering, press  (Thread cutter button) to cut the threads, raise the presser foot, remove the embroidery frame, and then replace the bobbin with one wound with plenty of embroidery bobbin thread.</p>													
20	The bobbin winder safety device has activated. Is the thread tangled?	This message is displayed when the bobbin is being wound, and the motor locks because the thread is tangled, etc.													
21	 The carriage of the embroidery unit will move. Keep your hands etc. away from the carriage.	This message appears before embroidery unit moves.													
22	The machine is still trying to connect to your wireless network.	The machine is still trying to connect to your wireless network. Please wait a few minutes, and then check the WLAN status.													
23	 The safety device has been activated. Is the thread tangled? Is the needle bent?	This message is displayed when the motor locks due to tangled thread or for other reasons related to thread delivery.													
24	The SSID and Network Key are incorrect.	<p>The security information (SSID/network key (password)) is incorrect. Reconfirm the SSID and security information (network key (password)). (page 18) Refer to "How can I find the wireless security information (SSID and network key)" on page 115.</p>													
25	The "Start/Stop" button does not operate with the foot controller attached. Remove the foot controller.	This message is displayed when the "Start/Stop" button is pressed to sew Utility stitches or Character/Decorative stitches while the foot controller is connected.													
26	The wireless LAN access point/router cannot be detected.	<p>The wireless access point/router cannot be detected.</p> <ol style="list-style-type: none"> Check the following 4 points. <ul style="list-style-type: none"> - Make sure that the wireless access point/router is powered on. - Move your machine to an area where no items can obstruct the wireless network signal, such as metal doors or walls, or closer to the wireless access point/router. - Temporarily place your machine within about 1 m (3.3 feet) from the wireless access point when you are configuring the wireless settings. - If your wireless access point/router is using MAC address filtering, confirm the MAC address of this machine is allowed in the filter. If you manually entered the SSID and security information (SSID/authentication method/encryption method/network key (password)), the information may be incorrect. Reconfirm the SSID and security information and re-enter the correct information as necessary. (page 18) Refer to "How can I find the wireless security information (SSID and network key)" on page 115. 													

	Error messages	Cause/solution
27	The wireless security information (Authentication method, Encryption method, Network Key) is incorrect.	The wireless security information (authentication method/encryption method/network key (password)) is incorrect. Refer to the table for the [The authentication and encryption methods used by the selected wireless LAN access point/router are not supported by your machine.] error message, and reconfirm the wireless security information (authentication method/encryption method/network key (password)). (page 18) Refer to “How can I find the wireless security information (SSID and network key)” on page 115.
28	The wireless setting is not activated.	The wireless network setting is not activated. Activate the wireless network. (page 18)
29	This pattern cannot be loaded as the pattern extends out of the editable area.	This message is displayed when the sample stitch pattern that you try to add with the MY CUSTOM STITCH function extends out of the stitching area. Select a different stitch pattern, or delete the existing stitch pattern (point).
30	This pattern cannot be used.	This message appears when you try to retrieve a pattern that cannot be used with this machine.
31	This USB media cannot be used.	This message is displayed when you try to use incompatible media.
32	 Turn off the power and replace the needle plate.	This message is displayed when you try to sew with a stitch other than a straight stitch (middle needle position) while the straight stitch needle plate is installed.
33	USB media is not loaded. Load USB media.	This message is displayed when you try to recall or save a pattern while no USB flash drive is loaded.
34	When the speed controller is set to control the zigzag stitch width, the "Start/Stop" button does not operate.	This message is displayed when the speed control lever is set to control the zigzag stitch width, and the “Start/Stop” button is pressed. Set [Width Control] to [OFF] in the settings screen (page 15), or use the foot controller to operate the machine.
35	F**	If error message [F**] appears in the LCD while the machine is being used, the machine may be malfunctioning. Contact your authorized Brother dealer or the nearest Brother authorized service center.

How can I find the wireless security information (SSID and network key)

- 1) You should see the documentation provided with your wireless access point/router.
- 2) The default SSID (wireless network name) could be the manufacturer's name or the model name.
- 3) If you do not know the security information, please consult the router manufacturer, your system administrator, or internet provider.
- 4) Some Wireless SSIDs and network keys (passwords) are case (upper case and lower case) sensitive. Please properly record your information.

- * The network key may also be described as a password, security key or encryption key.
- * If the wireless access point/router is not broadcasting the SSID, the SSID will not automatically be detected. You will have to manually enter the SSID.

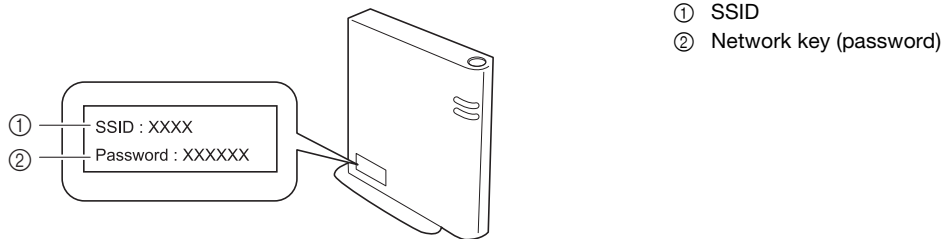

Operation beeps

If a correct operation is performed, the machine beeps one time.

If an incorrect operation is performed, the machine beeps two or four times.

If the machine locks up, for example, because the thread is tangled, the machine continues to beep for four seconds, and then the machine automatically stops. Be sure to check for the cause of the error, and correct it before continuing to sew.

Specifications

Item	Specification
Dimensions of machine	Approx. 480 mm (W) × 250 mm (D) × 300 mm (H) (Approx. 18-7/8 inches (W) × 9-7/8 inches (D) × 11-7/8 inches (H))
Weight of machine	<ul style="list-style-type: none"> • 888-G26 *1 Approx. 9.9 kg (Approx. 22 lb) • 888-G30/G32/G34 *1 Approx. 10 kg (Approx. 22 lb)
Dimensions of machine with embroidery unit attached	Approx. 693 mm (W) × 421 mm (D) × 300 mm (H) (Approx. 27-3/8 inches (W) × 16-5/8 inches (D) × 11-7/8 inches (H))
Weight of machine with embroidery unit attached	<ul style="list-style-type: none"> • 888-G26 *1 Approx. 13.4 kg (Approx. 30 lb) • 888-G30/G32/G34 *1 Approx. 13.5 kg (Approx. 30 lb)
Sewing speed	70 to 850 stitches per minute

*1 The product code is mentioned on the machine rating plate.

* Please be aware that some specifications may change without notice.

Updating Your Machine's Software

The machine's software can be updated using USB flash drive.

When an update program is available on the Brother support website at "<http://s.brother/cpham/>", please download the file(s) following the instructions on the website and steps listed below.

Note

- When using USB flash drive to update the software, check that no data other than the update file is saved on the USB flash drive being used before starting to update.

Memo

- When the machine's software is updated, saved embroidery patterns will not be erased.

When using the wireless function, the update mark is displayed on the wireless LAN key.

: Updated software is available on our website. Update the software.

: No updated software is available.

Version information can be checked from the settings screen. (page 16)

- 1 Turn on the machine while pressing and holding  (Presser foot lifter button).

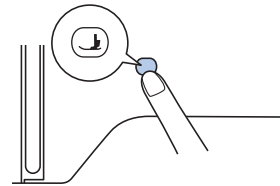

→ The following screen appears.

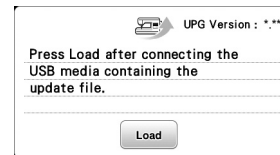

- 2 Insert the USB flash drive into the USB port on the machine.

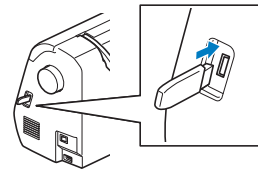

Note

- Save only the update file on the USB media.

- 3 Press .

- Do not turn off the machine during the update.

→ When updating is finished, the completion message appears.

- 4 Remove the USB flash drive, and turn the machine off and on again.

Index

Numerics

1/4" piecing foot 63

A

Adjustable zipper/piping foot 61
Aligning the position 99
Appliqué 62, 94, 95
Automatic fabric sensor system 36
Automatic thread cutting function 93

B

Ball point needle 27
Bar tack stitch 66
Blind hem stitch 54
Bobbin 20
 runs out of thread 90
Bobbin case 81, 104
Bobbin installation 22
Bobbin thread 20, 81
Bobbin winding 20
Bobbin winding thread guide 20
Button sewing 58
Buttonhole 56

C

Character spacing 14, 98
Cleaning 103
Cut/Tension key 91
Cylindrical pieces 40

D

Darning 67
Decorative stitches 13, 31
Denim 27, 41

E

Elastic tape 66
Embroidery 79
Embroidery foot 79
Embroidery frames 83, 84
 removing 85
Embroidery sheet 83
End Color Trim 93
Error messages 112
Even seam allowance 40

F

Fabric 27, 41, 82
Fagoting 68
Feed dog position switch 9, 64
Feed dogs 9
File format 74, 101
Font 33, 87
Foot controller 32
Free motion quilting 64

H

Heirloom stitching 72

I

Included accessories 11

Inserting a piping 62

J

Joining 70
Jump Stitch Trim 93

K

Knee lifter 43
Knee lifter mounting slot 43

L

L/R Shift 38
Language 16
LCD 11, 13
Leather 42
Light 16

M

Maintenance 103
Memory 74, 101
Metallic thread 21, 25
Mirroring 14, 97
MY CUSTOM STITCH 76

N

Needle 27, 28
Needle plate 9, 106
Needle plate cover 9, 103
Needle position 14, 15, 16, 40
Needle threader 25

O

Operation beep 16, 115
Overcasting stitches 52

P

Patchwork 62
Piecing 62
Piping inserting 62
Pivoting 37
Power supply 12
Presser foot 13, 29, 32, 45
 adjusting pressure 36
Presser foot holder 9
Pulling up bobbin thread 26

Q

Quilting 64
Quilting guide 64

R

Race 104
Reinforcement stitch 34
Retrieving 75, 77, 102
Reverse stitch 34
Rotate 97, 98

S

Satin stitch 14, 31
Saving 75, 101

Scallop stitching	69
Sewing speed controller	10
Shell tuck stitch	69
Size	14, 97
Smocking	69
Speed	21, 32
Split embroidery patterns	96
Spool cap	20
Spool net	21
Stabilizer	82
Step stitch patterns	72
Stitch guide foot	40
Stitch length	38
Stitch width	38
Straight stitch	40, 45, 62
Stretch fabrics	42

T

Terms of Use	5
Thick fabrics	41
Thin fabrics	42
Thread	27, 81
Thread color display	90
Thread color sorting	100
Thread cutting	32, 35
Thread density	14, 97
Thread tension	38, 91, 106
Thread trimming function	93
Transparent nylon thread	21, 22, 25, 27
Troubleshooting	105
Twin needle	71

U

Updating	116
Upper thread	24, 81
USB	74, 101

V

Vinyl fabrics	42
---------------------	----

W

Walking foot	64
Wing needle	72
Wireless LAN	17

Z

Zigzag stitch	38, 66
Zipper	59
Zipper insertion	
centered	61





Various optional accessories are available to be purchased separately.

Visit our website <http://s.brother/coham/>.



Please visit us at <http://s.brother/cpham/> where you can get product support and answers to frequently asked questions (FAQs).



Be sure to install the latest software.

A variety of functional improvements are being performed in the latest version.



Brother SupportCenter is a mobile app that provides the support information for your Brother product.

Visit the Google Play™ or App Store to download.



Google Play™



App Store

This machine is approved for use in the country of purchase only. Local Brother companies or their dealers will only support machines purchased in their own countries.



Design Database Transfer is a dedicated Windows application for wirelessly transferring embroidery data from a computer to the machine. This application can also be used to view and manage embroidery data.

Visit us at <http://s.brother/cahka/> to download the application.

English
888-G26/G30/G32/G34



D01W2B-101①